

INTERNAL DEFORMATION DUE TO SHEAR AND TENSILE FAULTS IN A HALF-SPACE

BY YOSHIMITSU OKADA

ABSTRACT

A complete set of closed analytical expressions is presented in a unified manner for the internal displacements and strains due to shear and tensile faults in a half-space for both point and finite rectangular sources. These expressions are particularly compact and systematically composed of terms representing deformations in an infinite medium, a term related to surface deformation and that is multiplied by the depth of observation point. Several practical suggestions to avoid mathematical singularities and computational instabilities are also presented. The expressions derived here represent powerful tools both for the observational and theoretical analyses of static field changes associated with earthquake and volcanic phenomena.

INTRODUCTION

Because our geophysical observations are restricted to near the ground surface, theoretical studies to derive expressions of various physical quantities at the surface of a half-space have primary practical importance. In a previous paper (Okada, 1985), we have obtained a complete set of compact closed analytical expressions for the surface deformation due to inclined shear and tensile faults in a half-space. The newly added solution for the surface displacement, strain, and tilt arising from tensile fault was successfully applied to the modeling of the 1986 Izu-Oshima eruption (Tada and Hashimoto, 1987; Yamamoto *et al.*, 1988), and the 1989 Off-Ito eruption (Okada and Yamamoto, 1991), both of which took place in the central part of Japan. As to the dynamic problem, the exact expressions for surface displacement and strain due to a shear fault in a half-space were respectively derived by Kawasaki *et al.* (1973, 1975) and Okada (1980), using the Cagniard-de Hoop method. On the other hand, static changes of surface gravity and piezomagnetic fields due to the dislocation sources in a half-space were formulated by Okubo (1989) and Sasai (1980), respectively. Recently, Pan (1989) added explicit expression for the surface displacement due to a point shear source in a transversely isotropic and layered half-space.

In this paper, we extend our previous work to the internal deformation fields due to shear and tensile faults in a half-space. The investigation of them is no less important than that of surface deformation. The expressions of such a field are necessary for rigorous interpretation of the strain and tilt data observed in deep boreholes. And, more essentially, they can contribute to the theoretical consideration of the seismic and volcanic sources, since they can account for the deformation fields in the entire volume surrounding the source regions.

Table 1 summarizes the progress to get analytical expressions for the internal deformation fields due to point and finite rectangular sources in a half-space. Steketee (1958) gave the expression for internal displacement field due to a point source of vertical strike-slip type in a Poisson half-space. Maruyama (1964) extended this work to arbitrary vertical and horizontal point sources.

Later, the internal displacement fields due to point sources in a general half-space were derived by Yamazaki (1978) for a horizontal tensile source, and by Iwasaki and Sato (1979) for an inclined shear source. However, neither the expression for internal displacement field due to an arbitrary point tensile source nor that for internal strain field due to any type of point source in a half-space are published.

As for finite rectangular sources, Chinnery (1961, 1963) gave the expression for internal displacement due to a vertical strike-slip fault in a general half-space. Mansinha and Smylie (1967, 1971) derived the formula to calculate internal displacement field due to an inclined shear fault in a Poisson half-space. Converse (1973) extended this work to a shear fault in a general half-space and added the formula for all displacement derivatives. Alewine (1974) also obtained the expression for internal strain field using Mansinha and Smylie's (1971) equations, although the differentiation was performed only in horizontal direction. Later, by a different approach, Iwasaki and Sato (1979) obtained the expressions for all the internal strain components due to an inclined shear fault in a general half-space. Recently, Yang and Davis (1986) added the solution for internal displacement field due to an inclined tensile fault in a general half-space, together with a computer program to calculate the internal displacement and strain. But their formula cannot be applied to a vertical tensile fault. As is shown in Table 1, a work that treats the internal deformation fields for all the cases in an unified manner does not exist. Furthermore, the published closed analytical expressions are generally too lengthy and complicated and hard to grasp their physical meaning. The first objective of this paper is to give a complete set of compact and systematic formula to calculate displacement and strain fields at depth as well as at the surface due to inclined shear and tensile faults in a general half-space for both point and finite rectangular sources.

Since the calculation of surface and internal deformation due to the formation of shear and tensile faults in a half-space is a fundamental tool for the investigation of seismic and volcanic sources, many practical systems to calculate them are in operation at various sites (e.g., DIS3D at U.S. Geological Survey; Erickson, 1986). In these systems, the expressions of Mansinha and Smylie (1971) as well as Yang and Davis (1986) are widely employed and translated to FORTRAN codes. However, they sometimes cause numerical problems for some special conditions. For example, since one of the integration ranges of Mansinha and Smylie's (1971) formula is taken along down-dip direction, it will become indefinite when the fault surface approaches horizontal. Also, it is not seldom that existing programs fail to give proper answers by facing zero-divide or zero-argument in logarithm and so on. The second objective of this paper is to state practical methods for avoiding such mathematical singularities and computational instabilities, which are inherently contained in the analytical expressions.

POINT SOURCE

We start from the formula to calculate the internal displacement field due to a single force in a homogeneous half-space. If we take the Cartesian coordinate system, as shown in Figure 1, $u_i^j(x_1, x_2, x_3; \xi_1, \xi_2, \xi_3)$, the i th component of the displacement at (x_1, x_2, x_3) due to the j th direction point force of magnitude F at (ξ_1, ξ_2, ξ_3) can be rewritten from the formula by Mindlin (1936) or Press

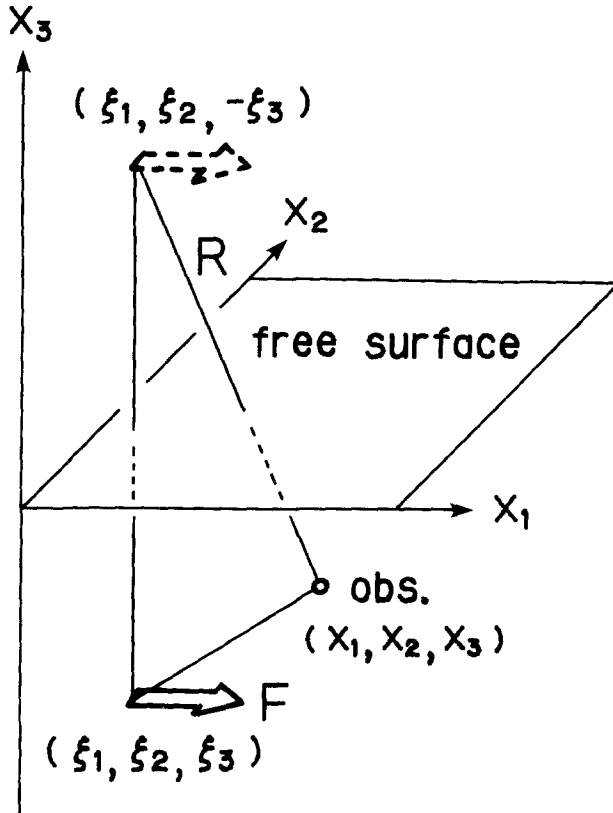

FIG. 1. A coordinate system adopted in this study.

(1965) as follows:

$$u_i^j(x_1, x_2, x_3) = u_{iA}^j(x_1, x_2, -x_3) - u_{iA}^j(x_1, x_2, x_3) + u_{iB}^j(x_1, x_2, x_3) + x_3 u_{iC}^j(x_1, x_2, x_3) \tag{1}$$

$$\left\{ \begin{aligned} u_{iA}^j &= \frac{F}{8\pi\mu} \left\{ (2 - \alpha) \frac{\delta_{ij}}{R} + \alpha \frac{R_i R_j}{R^3} \right\} \\ u_{iB}^j &= \frac{F}{4\pi\mu} \left\{ \frac{\delta_{ij}}{R} + \frac{R_i R_j}{R^3} + \frac{1 - \alpha}{\alpha} \left[\frac{\delta_{ij}}{R + R_3} + \frac{R_i \delta_{j3} - R_j \delta_{i3} (1 - \delta_{j3})}{R(R + R_3)} \right. \right. \\ &\quad \left. \left. - \frac{R_i R_j}{R(R + R_3)^2} (1 - \delta_{i3})(1 - \delta_{j3}) \right] \right\} \\ u_{iC}^j &= \frac{F}{4\pi\mu} (1 - 2\delta_{i3}) \left\{ (2 - \alpha) \frac{R_i \delta_{j3} - R_j \delta_{i3}}{R^3} + \alpha \xi_3 \left[\frac{\delta_{ij}}{R^3} - \frac{3R_i R_j}{R^5} \right] \right\}, \end{aligned} \right.$$

where, $\alpha = (\lambda + \mu)/(\lambda + 2\mu)$; λ and μ are Lamé's constants; δ_{ij} is the Kronecker delta; and $R_1 = x_1 - \xi_1$, $R_2 = x_2 - \xi_2$, $R_3 = -x_3 - \xi_3$, $R^2 = R_1^2 + R_2^2 + R_3^2$.

Here, $u_{iA}^j(x_1, x_2, -x_3)$, the first term in equation (1), is the well-known Somigliana tensor, which represents the displacement field due to a single force placed at (ξ_1, ξ_2, ξ_3) in an infinite medium (e.g., Love, 1927). The second term, $u_{iA}^j(x_1, x_2, x_3)$, also looks like a Somigliana tensor. This term corresponds to a contribution from an image source of the given point force placed at $(\xi_1, \xi_2, -\xi_3)$ in the infinite medium, although the polarity of the image source is switched from one component to another so as to cause the surface displacement to vanish when it is combined with the first term. The third term, $u_{iB}^j(x_1, x_2, x_3)$, and $u_{iC}^j(x_1, x_2, x_3)$ in the fourth term are naturally depth dependent. When we put x_3 to be zero in equation (1), the first and the second terms cancel each other, and the fourth term vanishes. The remaining term, $u_{iB}^j(x_1, x_2, 0)$, reduces to the formula for the surface displacement field due to a point force in a half-space (Okada, 1985). Thus, the fundamental equation to describe the internal displacement field due to a point single force in a half-space can be composed of two infinite medium terms (part A), a surface deformation related term (part B), and a depth multiplied term (part C).

In order to get the presentation for displacement fields due to strain nuclei, we need ξ_k -derivative of the equation (1). It is expressed as follows:

$$\begin{aligned} \frac{\partial u_i^j}{\partial \xi_k}(x_1, x_2, x_3) &= \frac{\partial u_{iA}^j}{\partial \xi_k}(x_1, x_2, -x_3) - \frac{\partial u_{iA}^j}{\partial \xi_k}(x_1, x_2, x_3) \\ &\quad + \frac{\partial u_{iB}^j}{\partial \xi_k}(x_1, x_2, x_3) + x_3 \frac{\partial u_{iC}^j}{\partial \xi_k}(x_1, x_2, x_3) \end{aligned} \quad (2)$$

$$\left\{ \begin{aligned} \frac{\partial u_{iA}^j}{\partial \xi_k} &= \frac{F}{8\pi\mu} \left\{ (2-\alpha) \frac{R_k}{R^3} \delta_{ij} - \alpha \frac{R_i \delta_{jk} + R_j \delta_{ik}}{R^3} + 3\alpha \frac{R_i R_j R_k}{R^5} \right\} \\ \frac{\partial u_{iB}^j}{\partial \xi_k} &= \frac{F}{4\pi\mu} \left\{ -\frac{R_i \delta_{jk} + R_j \delta_{ik} - R_k \delta_{ij}}{R^3} + \frac{3R_i R_j R_k}{R^5} \right. \\ &\quad + \frac{1-\alpha}{\alpha} \left[\frac{\delta_{3k} R + R_k}{R(R+R_3)^2} \delta_{ij} - \frac{\delta_{ik} \delta_{j3} - \delta_{jk} \delta_{i3} (1-\delta_{j3})}{R(R+R_3)} \right. \\ &\quad \left. \left. + [R_i \delta_{j3} - R_j \delta_{i3} (1-\delta_{j3})] \frac{\delta_{3k} R^2 + R_k (2R+R_3)}{R^3 (R+R_3)^2} \right. \right. \\ &\quad \left. \left. + \left[\frac{R_i \delta_{jk} + R_j \delta_{ik}}{R(R+R_3)^2} - R_i R_j \frac{2\delta_{3k} R^2 + R_k (3R+R_3)}{R^3 (R+R_3)^3} \right] (1-\delta_{i3})(1-\delta_{j3}) \right\} \\ \frac{\partial u_{iC}^j}{\partial \xi_k} &= \frac{F}{4\pi\mu} (1-2\delta_{i3}) \left\{ (2-\alpha) \left[\frac{\delta_{jk} \delta_{i3} - \delta_{ik} \delta_{j3}}{R^3} + \frac{3R_k (R_i \delta_{j3} - R_j \delta_{i3})}{R^5} \right] \right. \\ &\quad \left. + \alpha \left[\frac{\delta_{ij}}{R^3} - \frac{3R_i R_j}{R^5} \right] \delta_{3k} + 3\alpha \xi_3 \left[\frac{R_i \delta_{jk} + R_j \delta_{ik} + R_k \delta_{ij}}{R^5} - \frac{5R_i R_j R_k}{R^7} \right] \right\} \end{aligned} \right.$$

Now, let us advance to a practical problem. We consider three different point dislocation sources as well as an inflation (or explosive) point source, as shown

in Figure 2. All the point sources are assumed to be placed at $(0, 0, -c)$ of (x, y, z) coordinate system, where the x axis is taken parallel to the fault strike. The sense of the strike slip is left lateral for $\sin \delta > 0$ ($0 < \delta < \pi$) and right lateral for $\sin \delta < 0$ ($-\pi < \delta < 0$). The sense of the dip slip is reverse fault for $\sin 2\delta > 0$ ($0 < \delta < \pi/2$ or $-\pi < \delta < -\pi/2$) and normal fault for $\sin 2\delta < 0$ ($\pi/2 < \delta < \pi$ or $-\pi/2 < \delta < 0$).

According to Steketee (1958), the displacement field $u_i(x_1, x_2, x_3)$ due to a dislocation $\Delta u_j(\xi_1, \xi_2, \xi_3)$ across a surface Σ in an isotropic medium is given by

$$u_i = \frac{1}{F} \int \int_{\Sigma} \Delta u_j \left[\lambda \delta_{jk} \frac{\partial u_i^n}{\partial \xi_n} + \mu \left(\frac{\partial u_i^j}{\partial \xi_k} + \frac{\partial u_i^k}{\partial \xi_j} \right) \right] \nu_k d\Sigma, \tag{3}$$

where summation convention applies, and ν_k is the direction cosine of the normal to the surface element $d\Sigma$, i.e., $(0, -\sin \delta, \cos \delta)$ in the present case. Based on this formula and body force equivalent relations, the internal displacement field, \mathbf{u}° , corresponding to each point source can be expressed by a combination of the displacement fields due to strain nuclei, $\partial \mathbf{u}^j / \partial \xi_k$, as follows.

(a) Strike-slip point source (moment = M_0):

$$\mathbf{u}^\circ = \frac{M_0}{F} \left[- \left(\frac{\partial \mathbf{u}^1}{\partial \xi_2} + \frac{\partial \mathbf{u}^2}{\partial \xi_1} \right) \sin \delta + \left(\frac{\partial \mathbf{u}^1}{\partial \xi_3} + \frac{\partial \mathbf{u}^3}{\partial \xi_1} \right) \cos \delta \right]. \tag{4}$$

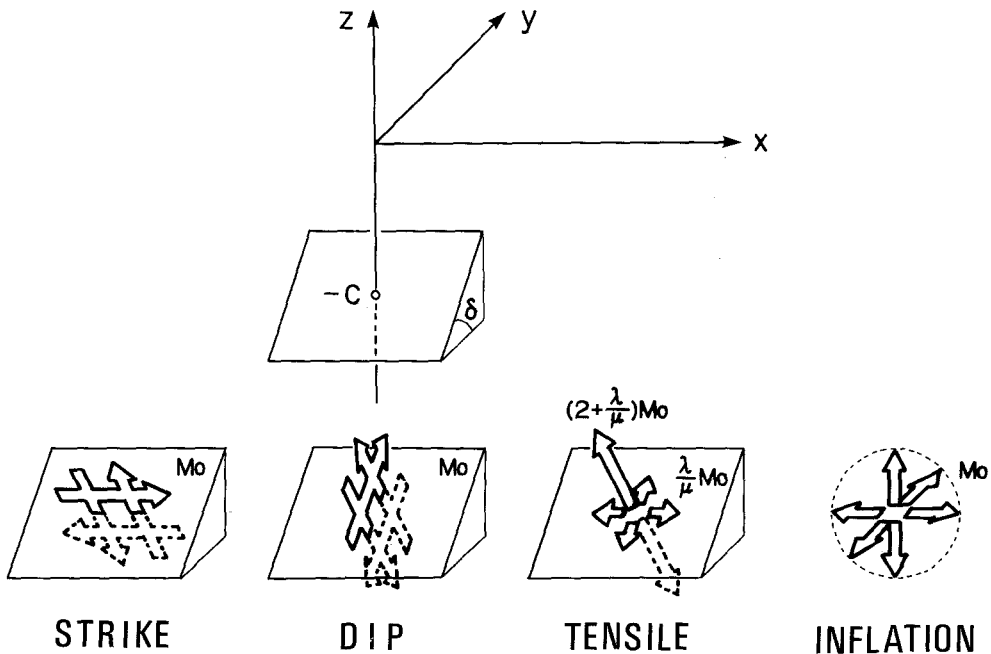

FIG. 2. Geometry of four different point sources, whose internal deformation fields are listed in Tables 2 through 5. See text as to sign convention for the slip vectors.

(b) Dip-slip point source (moment = M_0):

$$\mathbf{u}^\circ = \frac{M_0}{F} \left[\left(\frac{\partial \mathbf{u}^2}{\partial \xi_3} + \frac{\partial \mathbf{u}^3}{\partial \xi_2} \right) \cos 2\delta + \left(\frac{\partial \mathbf{u}^3}{\partial \xi_3} - \frac{\partial \mathbf{u}^2}{\partial \xi_2} \right) \sin 2\delta \right]. \quad (5)$$

(c) Tensile point source

(intensity = $(\lambda/\mu)M_0$ isotropic part and $2M_0$ uniaxial part):

$$\mathbf{u}^\circ = \frac{M_0}{F} \left[\frac{2\alpha - 1}{1 - \alpha} \frac{\partial \mathbf{u}^n}{\partial \xi_n} + 2 \left(\frac{\partial \mathbf{u}^2}{\partial \xi_2} \sin^2 \delta + \frac{\partial \mathbf{u}^3}{\partial \xi_3} \cos^2 \delta \right) - \left(\frac{\partial \mathbf{u}^2}{\partial \xi_3} + \frac{\partial \mathbf{u}^3}{\partial \xi_2} \right) \sin 2\delta \right]. \quad (6)$$

(d) Inflation point source (intensity = M_0):

$$\mathbf{u}^\circ = \frac{M_0}{F} \frac{\partial \mathbf{u}^n}{\partial \xi_n}. \quad (7)$$

We can obtain closed analytical expressions for each displacement field by substituting equation (2) into equations (4) through (7). The final results and their x , y , and z derivatives are given in Tables 2 through 5, where

$$\begin{aligned} A_3 &= 1 - \frac{3x^2}{R^2} & A_5 &= 1 - \frac{5x^2}{R^2} & A_7 &= 1 - \frac{7x^2}{R^2} \\ B_3 &= 1 - \frac{3y^2}{R^2} & B_5 &= 1 - \frac{5y^2}{R^2} & B_7 &= 1 - \frac{7y^2}{R^2} \\ C_3 &= 1 - \frac{3d^2}{R^2} & C_5 &= 1 - \frac{5d^2}{R^2} & C_7 &= 1 - \frac{7d^2}{R^2} \end{aligned} \quad (8)$$

In these tables, the top, middle, and bottom equations in each compartment represent the x , y , and z components, respectively. Necessary information to calculate the actual fields are included in each table. The total deformation field excluding that of the z derivative is expressed by a composition of two infinite medium terms (part A), a surface deformation related term (part B), and a depth multiplied term (part C). The internal strain and stress fields can be easily evaluated using the following relations.

$$e_{ij} = \frac{1}{2} \left(\frac{\partial u_i}{\partial x_j} + \frac{\partial u_j}{\partial x_i} \right), \quad (9)$$





$$\sigma_{ij} = \lambda e_{kk} \delta_{ij} + 2\mu e_{ij}. \quad (10)$$

FINITE RECTANGULAR SOURCE

Next, we consider three different finite rectangular sources, as shown in Figure 3. Sign convention for the slip vector is same as in the previous section. If we define fault length, L , along the fault strike direction, and width, W , along perpendicular direction to the strike, internal deformation field can be derived by taking $x - \xi'$, $y - \eta' \cos \delta$, and $c - \eta' \sin \delta$ in place of x , y , and c in the

TABLE 2

INTERNAL DISPLACEMENT FIELD DUE TO A POINT SOURCE IN A HALF-SPACE. THE TOP, MIDDLE, AND BOTTOM EQUATIONS IN EACH COMPARTMENT CORRESPOND TO X , Y , AND Z COMPONENTS, RESPECTIVELY.

Displacement due to a Point Source at $(0, 0, -c; \delta, M_0)$		$d = c - z$	$p = y \cos \delta + d \sin \delta$
		$R^2 = x^2 + y^2 + d^2$	$q = y \sin \delta - d \cos \delta$
$\mathbf{u}^\circ(x, y, z) = \frac{M_0}{2\pi\mu} [\mathbf{u}_A^\circ(x, y, z) - \mathbf{u}_A^\circ(x, y, -z) + \mathbf{u}_B^\circ(x, y, z) + z \mathbf{u}_C^\circ(x, y, z)]$		$\alpha = \frac{\lambda + \mu}{\lambda + 2\mu}$	$s = p \sin \delta + q \cos \delta$
			$t = p \cos \delta - q \sin \delta$
Type	\mathbf{u}_A°	\mathbf{u}_B°	\mathbf{u}_C°
Strike  M_0	$\frac{1-\alpha}{2} \frac{q}{R^3} + \frac{\alpha}{2} \frac{3x^2q}{R^5}$	$-\frac{3x^2q}{R^5} - \frac{1-\alpha}{\alpha} I_1^s \sin \delta$	$-(1-\alpha) \frac{A_3}{R^3} \cos \delta + \alpha \frac{3cq}{R^5} A_5$
	$\frac{1-\alpha}{2} \frac{x}{R^3} \sin \delta + \frac{\alpha}{2} \frac{3xyq}{R^5}$	$-\frac{3xyq}{R^5} - \frac{1-\alpha}{\alpha} I_2^s \sin \delta$	$(1-\alpha) \frac{3xy}{R^5} \cos \delta + \alpha \frac{3cx}{R^5} \left[\sin \delta - \frac{5yq}{R^2} \right]$
	$-\frac{1-\alpha}{2} \frac{x}{R^3} \cos \delta + \frac{\alpha}{2} \frac{3xdq}{R^5}$	$-\frac{3xdq}{R^5} - \frac{1-\alpha}{\alpha} I_4^s \sin \delta$	$-(1-\alpha) \frac{3xy}{R^5} \sin \delta + \alpha \frac{3cx}{R^5} \left[\cos \delta + \frac{5dq}{R^2} \right]$
Dip  M_0	$\frac{1-\alpha}{2} \frac{s}{R^3} + \frac{\alpha}{2} \frac{3ypq}{R^5}$	$-\frac{3ypq}{R^5} + \frac{1-\alpha}{\alpha} I_1^s \sin \delta \cos \delta$	$(1-\alpha) \frac{3xt}{R^5} - \alpha \frac{15cxpq}{R^7}$
	$-\frac{1-\alpha}{2} \frac{t}{R^3} + \frac{\alpha}{2} \frac{3dpq}{R^5}$	$-\frac{3dpq}{R^5} + \frac{1-\alpha}{\alpha} I_2^s \sin \delta \cos \delta$	$-(1-\alpha) \frac{1}{R^3} \left[\cos 2\delta - \frac{3yt}{R^2} \right] + \alpha \frac{3c}{R^5} \left[s - \frac{5ypq}{R^2} \right]$
Tensile  $2M_0$ λM_0 μM_0	$\frac{1-\alpha}{2} \frac{x}{R^3} - \frac{\alpha}{2} \frac{3xq^2}{R^5}$	$\frac{3xq^2}{R^5} - \frac{1-\alpha}{\alpha} I_3^s \sin^2 \delta$	$-(1-\alpha) \frac{3xs}{R^5} + \alpha \frac{15cxq^2}{R^7} - \alpha \frac{3xz}{R^5}$
	$\frac{1-\alpha}{2} \frac{t}{R^3} - \frac{\alpha}{2} \frac{3yq^2}{R^5}$	$\frac{3yq^2}{R^5} - \frac{1-\alpha}{\alpha} I_1^s \sin^2 \delta$	$(1-\alpha) \frac{1}{R^3} \left[\sin 2\delta - \frac{3ys}{R^2} \right] + \alpha \frac{3c}{R^5} \left[t - y + \frac{5yq^2}{R^2} \right] - \alpha \frac{3yz}{R^5}$
	$\frac{1-\alpha}{2} \frac{s}{R^3} - \frac{\alpha}{2} \frac{3dq^2}{R^5}$	$\frac{3dq^2}{R^5} - \frac{1-\alpha}{\alpha} I_5^s \sin^2 \delta$	$-(1-\alpha) \frac{1}{R^3} \left[1 - A_3 \sin^2 \delta \right] - \alpha \frac{3c}{R^5} \left[s - d + \frac{5dq^2}{R^2} \right] + \alpha \frac{3dz}{R^5}$
Inflation  M_0	$\frac{1-\alpha}{2} \frac{x}{R^3}$	$\frac{1-\alpha}{\alpha} \frac{x}{R^3}$	$(1-\alpha) \frac{3xd}{R^5}$
	$\frac{1-\alpha}{2} \frac{y}{R^3}$	$\frac{1-\alpha}{\alpha} \frac{y}{R^3}$	$(1-\alpha) \frac{3yd}{R^5}$
	$\frac{1-\alpha}{2} \frac{d}{R^3}$	$\frac{1-\alpha}{\alpha} \frac{d}{R^3}$	$(1-\alpha) \frac{C_3}{R^3}$

$$I_1^s = y \left[\frac{1}{R(R+d)^2} - x^2 \frac{3R+d}{R^3(R+d)^3} \right] \quad I_3^s = \frac{x}{R^3} - I_2^s \quad I_4^s = -xy \frac{2R+d}{R^3(R+d)^2}$$

$$I_2^s = x \left[\frac{1}{R(R+d)^2} - y^2 \frac{3R+d}{R^3(R+d)^3} \right] \quad I_5^s = \frac{1}{R(R+d)} - x^2 \frac{2R+d}{R^3(R+d)^2}$$

equations obtained in the previous section and by performing the integration

$$\int_0^L d\xi' \int_0^W d\eta'. \tag{11}$$





Following Sato and Matsu'ura (1974), it is convenient to change the integration variables from ξ', η' to ξ, η by

$$\begin{cases} x - \xi' = \xi \\ p - \eta' = \eta \end{cases} \tag{12}$$

where $p = y \cos \delta + d \sin \delta$, as before. After all, we need to substitute $\xi, \eta \cos \delta + q \sin \delta, \eta \sin \delta - q \cos \delta$, and η in place of x, y, d , and p in the equations for point sources, while keeping z and q unaltered. In this case, equation (11) becomes

$$\int_x^{x-L} d\xi \int_p^{p-W} d\eta. \tag{13}$$

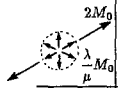
TABLE 3
X DERIVATIVES OF THE EQUATIONS IN TABLE 2.

X-derivative of displacement due to a Point Source at (0, 0, -c; δ, M ₀)			$d = c - z$	$p = y \cos \delta + d \sin \delta$
			$R^2 = x^2 + y^2 + d^2$	$q = y \sin \delta - d \cos \delta$
$\frac{\partial u^0}{\partial x}(x, y, z) = \frac{M_0}{2\pi\mu} \left[\frac{\partial u_A^0}{\partial x}(x, y, z) - \frac{\partial u_B^0}{\partial x}(x, y, -z) + \frac{\partial u_C^0}{\partial x}(x, y, z) + z \frac{\partial u_C^0}{\partial x}(x, y, z) \right]$			$\alpha = \frac{\lambda + \mu}{\lambda + 2\mu}$	$s = p \sin \delta + q \cos \delta$
				$t = p \cos \delta - q \sin \delta$
Type	$\partial u_A^0 / \partial x$	$\partial u_B^0 / \partial x$	$\partial u_C^0 / \partial x$	
 Strike M ₀	$-\frac{1-\alpha}{2} \frac{3\pi q}{R^5} + \frac{\alpha}{2} \frac{3\pi q}{R^5}(1+A_5)$	$-\frac{3\pi q}{R^5}(1+A_5) - \frac{1-\alpha}{\alpha} J_1^0 \sin \delta$	$(1-\alpha) \frac{3\pi}{R^5}(2+A_5) \cos \delta$	$-\alpha \frac{15c\pi q}{R^7}(2+A_7)$
	$\frac{1-\alpha}{2} \frac{A_3}{R^3} \sin \delta + \frac{\alpha}{2} \frac{3\pi q}{R^5} A_5$	$-\frac{3\pi q}{R^5} A_5 - \frac{1-\alpha}{\alpha} J_2^0 \sin \delta$	$(1-\alpha) \frac{3\pi}{R^5} A_5 \cos \delta$	$+\alpha \frac{3c}{R^5} [A_5 \sin \delta - \frac{5\pi q}{R^2} A_7]$
	$\frac{1-\alpha}{2} \frac{A_3}{R^3} \cos \delta + \frac{\alpha}{2} \frac{3\pi q}{R^5} A_5$	$-\frac{3\pi q}{R^5} A_5 - \frac{1-\alpha}{\alpha} K_1^0 \sin \delta$	$-(1-\alpha) \frac{3\pi}{R^5} A_5 \sin \delta$	$+\alpha \frac{3c}{R^5} [A_5 \cos \delta + \frac{5\pi q}{R^2} A_7]$
 Dip M ₀	$\frac{\alpha}{2} \frac{3\pi q}{R^5} A_5$	$-\frac{3\pi q}{R^5} A_5 + \frac{1-\alpha}{\alpha} J_3^0 \sin \delta \cos \delta$	$(1-\alpha) \frac{3\pi}{R^5} A_5$	$-\alpha \frac{15c\pi q}{R^7} A_7$
	$-\frac{1-\alpha}{2} \frac{3\pi s}{R^5} + \frac{\alpha}{2} \frac{15\pi y p q}{R^7}$	$-\frac{1-\alpha}{\alpha} J_1^0 \sin \delta \cos \delta + \frac{15\pi y p q}{R^7}$	$(1-\alpha) \frac{3\pi}{R^5} [\cos 2\delta - \frac{5\pi t}{R^2}]$	$-\alpha \frac{15c\pi}{R^7} [s - \frac{7\pi p q}{R^2}]$
	$\frac{1-\alpha}{2} \frac{3\pi t}{R^5} + \frac{\alpha}{2} \frac{15\pi d p q}{R^7}$	$-\frac{1-\alpha}{\alpha} K_3^0 \sin \delta \cos \delta + \frac{15\pi d p q}{R^7}$	$(1-\alpha) \frac{3\pi}{R^5} (2+A_5) \sin \delta \cos \delta$	$-\alpha \frac{15c\pi}{R^7} [t + \frac{7\pi d p q}{R^2}]$
 Tensile 2M ₀ M ₀	$-\frac{1-\alpha}{2} \frac{A_3}{R^3} + \frac{\alpha}{2} \frac{3q^2}{R^5} A_5$	$\frac{3q^2}{R^5} A_5 - \frac{1-\alpha}{\alpha} J_3^0 \sin^2 \delta$	$-(1-\alpha) \frac{3\pi}{R^5} A_5$	$+\alpha \frac{15c\pi q^2}{R^7} A_7 - \alpha \frac{3\pi}{R^5} A_5$
	$-\frac{1-\alpha}{2} \frac{3\pi t}{R^5} + \frac{\alpha}{2} \frac{15\pi y q^2}{R^7}$	$-\frac{1-\alpha}{\alpha} J_1^0 \sin^2 \delta + \frac{15\pi y q^2}{R^7}$	$-(1-\alpha) \frac{3\pi}{R^5} [\sin 2\delta - \frac{5\pi s}{R^2}]$	$-\alpha \frac{15c\pi}{R^7} [t - y + \frac{7\pi q^2}{R^2}] + \alpha \frac{15\pi y z}{R^7}$
	$\frac{1-\alpha}{2} \frac{3\pi s}{R^5} + \frac{\alpha}{2} \frac{15\pi d q^2}{R^7}$	$-\frac{1-\alpha}{\alpha} K_3^0 \sin^2 \delta + \frac{15\pi d q^2}{R^7}$	$(1-\alpha) \frac{3\pi}{R^5} [1 - (2+A_5) \sin^2 \delta] + \alpha \frac{15c\pi}{R^7} [s - d + \frac{7\pi d q^2}{R^2}]$	$-\alpha \frac{15\pi d z}{R^7}$
 Inflation M ₀	$-\frac{1-\alpha}{2} \frac{A_3}{R^3}$	$-\frac{1-\alpha}{\alpha} \frac{A_3}{R^3}$	$(1-\alpha) \frac{3d}{R^5} A_5$	
	$\frac{1-\alpha}{2} \frac{3\pi y}{R^5}$	$-\frac{1-\alpha}{\alpha} \frac{3\pi y}{R^5}$	$-(1-\alpha) \frac{15\pi y d}{R^7}$	
	$\frac{1-\alpha}{2} \frac{3\pi d}{R^5}$	$-\frac{1-\alpha}{\alpha} \frac{3\pi d}{R^5}$	$-(1-\alpha) \frac{3\pi}{R^5} C_5$	

$$\begin{aligned}
 J_1^0 &= -3xy \left[\frac{3R+d}{R^3(R+d)^3} - z^2 \frac{5R^2+4Rd+d^2}{R^5(R+d)^4} \right] & K_1^0 &= -y \left[\frac{2R+d}{R^3(R+d)^3} - z^2 \frac{8R^2+9Rd+3d^2}{R^5(R+d)^3} \right] \\
 J_2^0 &= \frac{1}{R^3} - \frac{3}{R(R+d)^2} + 3z^2 y^2 \frac{5R^2+4Rd+d^2}{R^5(R+d)^4} & K_2^0 &= -z \left[\frac{2R+d}{R^3(R+d)^3} - y^2 \frac{8R^2+9Rd+3d^2}{R^5(R+d)^3} \right] \\
 J_3^0 &= \frac{A_3}{R^3} - J_2^0 & K_3^0 &= -\frac{3\pi d}{R^5} - K_2^0
 \end{aligned}$$

The final results of the evaluation of integral (13) for each component of displacements and their x, y, and z derivatives are given in Tables 6 through 9, where





$$\begin{aligned}
 X_{11} &= \frac{1}{R(R+\xi)} & X_{32} &= \frac{2R+\xi}{R^3(R+\xi)^2} & X_{53} &= \frac{8R^2+9R\xi+3\xi^2}{R^5(R+\xi)^3} \\
 Y_{11} &= \frac{1}{R(R+\eta)} & Y_{32} &= \frac{2R+\eta}{R^3(R+\eta)^2} & Y_{53} &= \frac{8R^2+9R\eta+3\eta^2}{R^5(R+\eta)^3} \\
 h &= q \cos \delta - z & Z_{32} &= \frac{\sin \delta}{R^3} - hY_{32} & Z_{53} &= \frac{3 \sin \delta}{R^5} - hY_{53} \\
 Y_0 &= Y_{11} - \xi^2 Y_{32} & Z_0 &= Z_{32} - \xi^2 Z_{53} & & (14)
 \end{aligned}$$

and || denotes Chinnery's notation to represent the substitution

$$f(\xi, \eta) || = f(x, p) - f(x, p - W) - f(x - L, p) + f(x - L, p - W). \quad (15)$$

Again, the total deformation field excluding that of the z derivative is expressed by a composition of two infinite medium terms (part A), a surface deformation related term (part B), and a depth multiplied term (part C). The

TABLE 4
 Y DERIVATIVES OF THE EQUATIONS IN TABLE 2. J_1^0 TO J_4^0 AND K_1^0, K_2^0 ARE LISTED IN TABLE 3.

Type	$\frac{\partial u_A^0}{\partial y}$	$\frac{\partial u_B^0}{\partial y}$	$\frac{\partial u_C^0}{\partial y}$	$\frac{\partial u^0}{\partial y}$
Strike	$\frac{1-\alpha}{2} \frac{1}{R^3} [\sin \delta - \frac{3yq}{R^2}] + \frac{\alpha}{2} \frac{3x^2}{R^5} U$	$-\frac{3x^2}{R^5} U$	$-\frac{1-\alpha}{\alpha} J_2^0 \sin \delta$	$(1-\alpha) \frac{3y}{R^5} A_5 \cos \delta + \alpha \frac{3c}{R^5} [A_5 \sin \delta - \frac{5yq}{R^2} A_7]$
 M_0	$-\frac{1-\alpha}{2} \frac{3xy}{R^5} \sin \delta + \frac{\alpha}{2} \frac{3xy}{R^5} U + \frac{\alpha}{2} \frac{3xq}{R^5}$	$-\frac{3xy}{R^5} U - \frac{3xq}{R^5}$	$-\frac{1-\alpha}{\alpha} J_2^0 \sin \delta$	$(1-\alpha) \frac{3x}{R^5} B_5 \cos \delta - \alpha \frac{15cx}{R^7} [2y \sin \delta + qB_7]$
Dip	$\frac{1-\alpha}{2} \frac{1}{R^3} [\sin 2\delta - \frac{3yq}{R^2}] + \frac{\alpha}{2} \frac{3x^2}{R^5} U$	$-\frac{3x^2}{R^5} U$	$-\frac{1-\alpha}{\alpha} K_2^0 \sin \delta$	$-(1-\alpha) \frac{3x}{R^5} B_5 \sin \delta + \alpha \frac{15cx}{R^7} [dB_7 \sin \delta - yC_7 \cos \delta]$
 M_0	$-\frac{1-\alpha}{2} \frac{1}{R^3} [\cos 2\delta - \frac{3yt}{R^2}] + \frac{\alpha}{2} \frac{3d}{R^5} V$	$-\frac{3x}{R^5} V$	$-\frac{1-\alpha}{\alpha} J_1^0 \sin \delta \cos \delta$	$(1-\alpha) \frac{3x}{R^5} [\cos 2\delta - \frac{5yt}{R^2}] - \alpha \frac{15cx}{R^7} [s - \frac{7yq}{R^2}]$
Tensile	$\frac{1-\alpha}{2} \frac{1}{R^3} [\sin 2\delta - \frac{3yq}{R^2}] + \frac{\alpha}{2} \frac{3yq}{R^5} W$	$-\frac{3y}{R^5} V - \frac{3yq}{R^5}$	$-\frac{1-\alpha}{\alpha} J_2^0 \sin \delta \cos \delta$	$(1-\alpha) \frac{3}{R^5} [2y \cos 2\delta + tB_5] + \alpha \frac{3c}{R^5} [\sin 2\delta - \frac{10ys}{R^2} - \frac{5yq}{R^2} B_7]$
 $2M_0$	$-\frac{1-\alpha}{2} \frac{1}{R^3} [\cos 2\delta - \frac{3yt}{R^2}] + \frac{\alpha}{2} \frac{3d}{R^5} V$	$-\frac{3c}{R^5} V$	$-\frac{1-\alpha}{\alpha} K_1^0 \sin \delta \cos \delta$	$(1-\alpha) \frac{3y}{R^5} A_5 \sin \delta \cos \delta - \alpha \frac{3c}{R^5} [(3+A_5) \cos 2\delta + \frac{35yq}{R^4}]$
 M_0	$\frac{1-\alpha}{2} \frac{3xy}{R^5} - \frac{\alpha}{2} \frac{3xyq}{R^5} W$	$\frac{3xyq}{R^5} W$	$-\frac{1-\alpha}{\alpha} J_1^0 \sin^2 \delta$	$-(1-\alpha) \frac{3x}{R^5} [\sin 2\delta - \frac{5ys}{R^2}] - \alpha \frac{15cx}{R^7} [t - y + \frac{7yq^2}{R^2}] + \alpha \frac{15x^2yz}{R^7}$
Inflation	$\frac{1-\alpha}{2} \frac{1}{R^3} [\cos 2\delta - \frac{3yt}{R^2}] - \frac{\alpha}{2} \frac{3yq}{R^5} W$	$\frac{3yq}{R^5} W + \frac{3q^2}{R^5}$	$-\frac{1-\alpha}{\alpha} J_2^0 \sin^2 \delta$	$-(1-\alpha) \frac{3}{R^5} [2y \sin 2\delta + tB_5] - \alpha \frac{3c}{R^5} [2 \sin^2 \delta + \frac{10y(t-y)}{R^2} - \frac{5q^2}{R^2} B_7] - \alpha \frac{3z}{R^5} B_5$
 M_0	$\frac{1-\alpha}{2} \frac{1}{R^3} [\sin 2\delta - \frac{3yq}{R^2}] - \frac{\alpha}{2} \frac{3dq}{R^5} W$	$\frac{3cq}{R^5} W$	$-\frac{1-\alpha}{\alpha} K_1^0 \sin^2 \delta$	$(1-\alpha) \frac{3y}{R^5} [1 - A_5 \sin^2 \delta] + \alpha \frac{3c}{R^5} [(3+A_5) \sin 2\delta - \frac{5yd}{R^2} (2 - \frac{7q^2}{R^2})] - \alpha \frac{15ydz}{R^7}$

Y-derivative of displacement due to a Point Source at $(0, 0, -c; \delta, M_0)$

$$\frac{\partial u^0}{\partial y}(x, y, z) = \frac{M_0}{2\pi\mu} \left[\frac{\partial u_A^0}{\partial y}(x, y, z) - \frac{\partial u_B^0}{\partial y}(x, y, -z) + \frac{\partial u_C^0}{\partial y}(x, y, z) \right]$$

$$d = c - z \quad p = y \cos \delta + d \sin \delta \quad U = \sin \delta - \frac{5yq}{R^2}$$

$$R^2 = x^2 + y^2 + d^2 \quad q = y \sin \delta - d \cos \delta \quad V = s - \frac{5yq}{R^2}$$

$$\alpha = \frac{\lambda + \mu}{\lambda + 2\mu} \quad s = p \sin \delta + q \cos \delta \quad W = \sin \delta + U$$

$$t = p \cos \delta - q \sin \delta$$

TABLE 5
Z DERIVATIVES OF THE EQUATIONS IN TABLE 2. K_1^0 TO K_3^0 ARE LISTED IN TABLE 3.

Z-derivative of displacement due to a Point Source at $(0, 0, -c; \delta, M_0)$

$$\frac{\partial u^0}{\partial z}(x, y, z) = \frac{M_0}{2\pi\mu} \left[\frac{\partial u_A^0}{\partial z}(x, y, z) + \frac{\partial u_B^0}{\partial z}(x, y, z) + z \frac{\partial u_C^0}{\partial z}(x, y, z) \right]$$

$$d = c - z$$

$$R^2 = x^2 + y^2 + d^2$$

$$\alpha = \frac{\lambda + \mu}{\lambda + 2\mu}$$

$$p = y \cos \delta + d \sin \delta$$

$$q = y \sin \delta - d \cos \delta$$







$$s = p \sin \delta + q \cos \delta$$

$$t = p \cos \delta - q \sin \delta$$

$$U' = \cos \delta + \frac{5dq}{R^2}$$

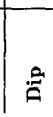
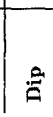
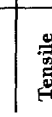
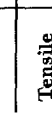
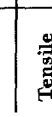
$$V' = t + \frac{5dpq}{R^2}$$

$$W' = \cos \delta + U'$$

Type	$\frac{\partial u_A^0}{\partial z}$	$\frac{\partial u_B^0}{\partial z}$	$\frac{\partial u_C^0}{\partial z}$
Strike 	$\frac{1-\alpha}{2} \frac{1}{R^3} \left[\cos \delta + \frac{3dq}{R^2} \right] + \frac{\alpha}{2} \frac{3x^2}{R^5} U'$	$-\frac{3x^2}{R^5} U' + \frac{1-\alpha}{\alpha} K_1^0 \sin \delta$	$-(1-\alpha) \frac{3d}{R^5} A_5 \cos \delta$
M_0 	$\frac{1-\alpha}{2} \frac{3xd}{R^5} \sin \delta + \frac{\alpha}{2} \frac{3xy}{R^5} U'$	$-\frac{3xy}{R^5} U' + \frac{1-\alpha}{\alpha} K_2^0 \sin \delta$	$+(1-\alpha) \frac{15xyd}{R^7} \cos \delta$
M_0 	$-\frac{1-\alpha}{2} \frac{3xd}{R^5} \cos \delta + \frac{\alpha}{2} \frac{3xd}{R^5} U' - \frac{\alpha}{2} \frac{3xq}{R^5}$	$-\frac{3cx}{R^5} U' + \frac{1-\alpha}{\alpha} \frac{3xy}{R^5} \sin \delta$	$-(1-\alpha) \frac{15xyd}{R^7} \sin \delta$
Dip 	$\frac{1-\alpha}{2} \frac{1}{R^3} \left[\cos 2\delta + \frac{3ds}{R^2} \right] + \frac{\alpha}{2} \frac{3y}{R^5} V'$	$-\frac{3x}{R^5} V' - \frac{1-\alpha}{\alpha} K_3^0 \sin \delta \cos \delta$	$-\alpha \frac{15cx}{R^7} \left[t + \frac{7dpq}{R^2} \right]$
M_0 	$\frac{1-\alpha}{2} \frac{1}{R^3} \left[\sin 2\delta - \frac{3dt}{R^2} \right] + \frac{\alpha}{2} \frac{3d}{R^5} V' - \frac{\alpha}{2} \frac{3yq}{R^5}$	$-\frac{3y}{R^5} V' - \frac{1-\alpha}{\alpha} K_1^0 \sin \delta \cos \delta$	$-(1-\alpha) \frac{3}{R^5} [dB_5 \cos 2\delta + yC_5 \sin 2\delta] - \alpha \frac{3c}{R^5} [(3 + A_5) \cos 2\delta + \frac{35ydpq}{R^4}]$
Tensile 	$\frac{1-\alpha}{2} \frac{3xd}{R^5} - \frac{\alpha}{2} \frac{3xq}{R^5} W'$	$-\frac{3cx}{R^5} + \frac{1-\alpha}{\alpha} A_3 \sin \delta \cos \delta$	$-(1-\alpha) \frac{3d}{R^5} A_5 \sin \delta \cos \delta$
$2M_0$ 	$-\frac{1-\alpha}{2} \frac{1}{R^3} \left[\sin 2\delta - \frac{3dt}{R^2} \right] - \frac{\alpha}{2} \frac{3yq}{R^5} W'$	$\frac{3xq}{R^5} W' + \frac{1-\alpha}{\alpha} K_3^0 \sin^2 \delta$	$-(1-\alpha) \frac{3x}{R^5} \left[\cos 2\delta + \frac{5ds}{R^2} \right] + \alpha \frac{15cx}{R^7} \left[s - d + \frac{7dq^2}{R^2} \right] - \alpha \frac{3x}{R^5} \left[1 + \frac{5dz}{R^2} \right]$
M_0 	$\frac{1-\alpha}{2} \frac{1}{R^3} \left[\cos 2\delta + \frac{3ds}{R^2} \right] - \frac{\alpha}{2} \frac{3yq}{R^5} W'$	$\frac{3yq}{R^5} W' + \frac{1-\alpha}{\alpha} K_1^0 \sin^2 \delta$	$(1-\alpha) \frac{3}{R^5} [dB_5 \sin 2\delta - yC_5 \cos 2\delta] + \alpha \frac{3c}{R^5} [(3 + A_5) \sin 2\delta - \frac{5y^2}{R^2} (2 - \frac{7q^2}{R^2})] - \alpha \frac{3y}{R^5} \left[1 + \frac{5dz}{R^2} \right]$
Inflation 	$\frac{1-\alpha}{2} \frac{3xd}{R^5}$	$-\frac{3cx}{R^5} W' - \frac{1-\alpha}{\alpha} A_3 \sin^2 \delta$	$-(1-\alpha) \frac{3d}{R^5} \left[\cos 2\delta + \frac{10d(s-d)}{R^2} - \frac{5\alpha^2}{R^2} C_7 \right] - \alpha \frac{3z}{R^5} (1 + C_5)$
M_0 	$-\frac{1-\alpha}{2} \frac{3yd}{R^5}$	$\frac{1-\alpha}{\alpha} \frac{3xd}{R^5}$	$-(1-\alpha) \frac{3x}{R^5} C_5$
M_0 	$\frac{1-\alpha}{2} \frac{1}{R^3} \left[\cos 2\delta + \frac{3ds}{R^2} \right] - \frac{\alpha}{2} \frac{3yq}{R^5} W'$	$-\frac{1-\alpha}{\alpha} \frac{3yd}{R^5}$	$-(1-\alpha) \frac{3y}{R^5} C_5$
M_0 	$\frac{1-\alpha}{2} \frac{1}{R^3} \left[\sin 2\delta - \frac{3dt}{R^2} \right] - \frac{\alpha}{2} \frac{3yq}{R^5} W'$	$-\frac{1-\alpha}{\alpha} \frac{C_5}{R^3}$	$(1-\alpha) \frac{3d}{R^5} (2 + C_5)$

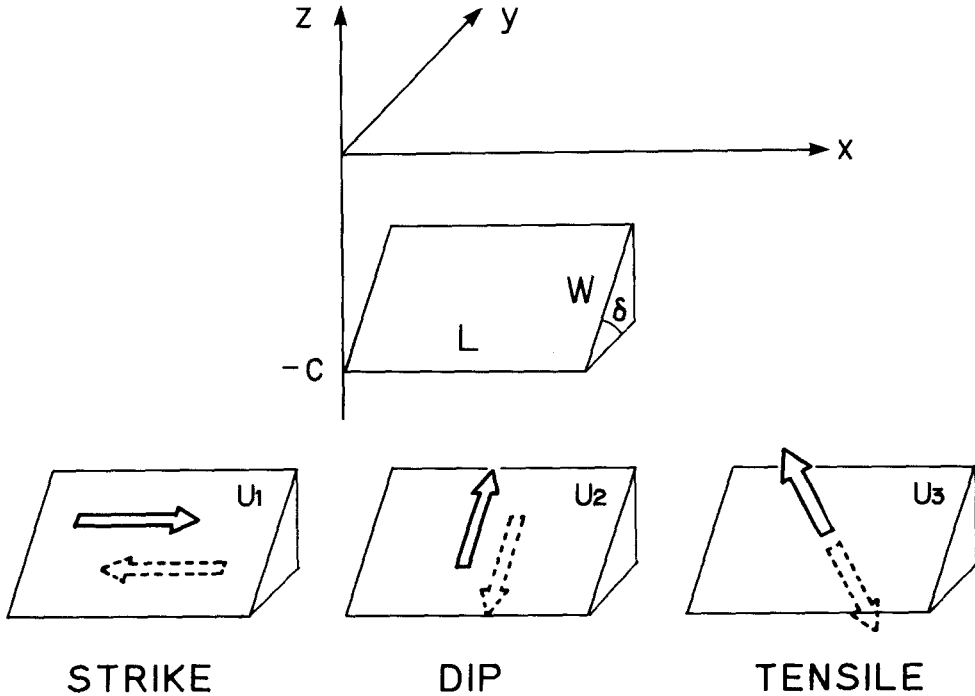

FIG. 3. Geometry of three different finite rectangular sources, whose internal deformation fields are listed in Tables 6 through 9. See text as to sign convention for the slip vectors.

physical meaning of several constants or variables that appear in these tables and equation (14) are illustrated in Figure 4.

For simplicity of expressions, the top, middle, and bottom equations, f_1 , f_2 , and f_3 , in each compartment of Tables 6 through 9 do not directly correspond to x , y , and z components f_x , f_y , and f_z . Instead, $f_1 = f_x$, $f_2 = f_y \cos \delta + f_z \sin \delta$, and $f_3 = -f_y \sin \delta + f_z \cos \delta$ are displayed for parts A and B. The latter two correspond to the components in the up-dip and normal directions of the real fault, i.e., the directions parallel to the (p) axis and opposite to the (q) axis in Figure 4, respectively. On the other hand, for part C $f_1 = f_x$, $f_2 = f_y \cos \delta - f_z \sin \delta$, and $f_3 = -f_y \sin \delta - f_z \cos \delta$ are displayed, the latter two of which correspond to the components in the image directions of those for parts A and B, i.e., the directions parallel to p axis and opposite to q axis in Figure 4, respectively. So, we must carry out the following conversion to get the x , y , and z components of each quantity.

$$\begin{cases} f_x = f_1 \\ f_y = f_2 \cos \delta - f_3 \sin \delta \\ f_z = f_2 \sin \delta + f_3 \cos \delta \end{cases} \quad \text{for parts A and B,} \quad (16)$$



$$\begin{cases} f_x = f_1 \\ f_y = f_2 \cos \delta - f_3 \sin \delta \\ f_z = -f_2 \sin \delta - f_3 \cos \delta \end{cases} \quad \text{for part C.} \quad (17)$$

TABLE 6
INTERNAL DISPLACEMENT FIELD DUE TO A FINITE RECTANGULAR SOURCE IN A HALF-SPACE.
SEE TEXT AS TO THE MEANING OF THE TOP, MIDDLE, AND BOTTOM EQUATIONS
IN EACH COMPARTMENT.

Displacement due to a Finite Fault at (0, 0, -c; δ, L, W, U)

$$\begin{cases} u_x(x, y, z) = U/2\pi [u_1^A - \bar{u}_1^A + u_1^B + z u_1^C] & d = c - z & R^2 = \xi^2 + \eta^2 + q^2 \\ u_y(x, y, z) = U/2\pi [(u_2^A - \bar{u}_2^A + u_2^B + z u_2^C) \cos \delta - (u_3^A - \bar{u}_3^A + u_3^B + z u_3^C) \sin \delta] & p = y \cos \delta + d \sin \delta & \bar{y} = \eta \cos \delta + q \sin \delta \\ u_z(x, y, z) = U/2\pi [(u_2^A - \bar{u}_2^A + u_2^B - z u_2^C) \sin \delta + (u_3^A - \bar{u}_3^A + u_3^B - z u_3^C) \cos \delta] & q = y \sin \delta - d \cos \delta & \bar{d} = \eta \sin \delta - q \cos \delta \\ & \alpha = (\lambda + \mu)/(\lambda + 2\mu) & \bar{c} = \bar{d} + z \end{cases}$$

$$u_1^A = f^A(\xi, \eta, z) \Big|_{z=0}^{z=-L} \Big|_{\eta=0}^{\eta=W} \quad \bar{u}_1^A = f^A(\xi, \eta, -z) \quad u_1^B = f^B(\xi, \eta, z) \quad u_1^C = f^C(\xi, \eta, z)$$

Type	f ^A	f ^B	f ^C	
Strike 	$\frac{\Theta}{2} + \frac{\alpha}{2} \xi q Y_{11}$ $\frac{\alpha}{2} \frac{q}{R}$ $\frac{1-\alpha}{2} \ln(R+\eta) - \frac{\alpha}{2} q^2 Y_{11}$	$-\xi q Y_{11} - \Theta$ $-\frac{q}{R}$ $q^2 Y_{11}$	$-\frac{1-\alpha}{\alpha} J_1 \sin \delta$ $+\frac{1-\alpha}{\alpha} \frac{\bar{y}}{R+d} \sin \delta$ $-\frac{1-\alpha}{\alpha} J_2 \sin \delta$	$(1-\alpha) \xi Y_{11} \cos \delta$ $(1-\alpha) \left[\frac{\cos \delta}{R} + 2q Y_{11} \sin \delta \right] - \alpha \frac{\bar{c} q}{R^2}$ $(1-\alpha) q Y_{11} \cos \delta$ $-\alpha \left[\frac{\bar{c} \eta}{R^2} - z Y_{11} + \xi^2 Z_{32} \right]$
Dip 	$\frac{\alpha}{2} \frac{q}{R}$ $\frac{\Theta}{2} + \frac{\alpha}{2} \eta q X_{11}$ $\frac{1-\alpha}{2} \ln(R+\xi) - \frac{\alpha}{2} q^2 X_{11}$	$-\frac{q}{R}$ $-\eta q X_{11} - \Theta$ $q^2 X_{11}$	$+\frac{1-\alpha}{\alpha} J_3 \sin \delta \cos \delta$ $-\frac{1-\alpha}{\alpha} \frac{\xi}{R+d} \sin \delta \cos \delta$ $+\frac{1-\alpha}{\alpha} J_4 \sin \delta \cos \delta$	$(1-\alpha) \frac{\cos \delta}{R} - q Y_{11} \sin \delta - \alpha \frac{\bar{c} q}{R^2}$ $(1-\alpha) \bar{y} X_{11}$ $-\bar{d} X_{11} - \xi Y_{11} \sin \delta - \alpha \bar{c} [X_{11} - q^2 X_{32}]$
Tensile 	$-\frac{1-\alpha}{2} \ln(R+\eta) - \frac{\alpha}{2} q^2 Y_{11}$ $-\frac{1-\alpha}{2} \ln(R+\xi) - \frac{\alpha}{2} q^2 X_{11}$ $\frac{\Theta}{2} - \frac{\alpha}{2} q(\eta X_{11} + \xi Y_{11})$	$q^2 Y_{11}$ $q^2 X_{11}$ $q(\eta X_{11} + \xi Y_{11}) - \Theta - \frac{1-\alpha}{\alpha} J_4 \sin^2 \delta$	$-\frac{1-\alpha}{\alpha} J_3 \sin^2 \delta$ $+\frac{1-\alpha}{\alpha} \frac{\xi}{R+d} \sin^2 \delta$ $-\frac{1-\alpha}{\alpha} J_4 \sin^2 \delta$	$-(1-\alpha) \left[\frac{\sin \delta}{R} + q Y_{11} \cos \delta \right] - \alpha [z Y_{11} - q^2 Z_{32}]$ $(1-\alpha) 2 \xi Y_{11} \sin \delta + \bar{d} X_{11} - \alpha \bar{c} [X_{11} - q^2 X_{32}]$ $(1-\alpha) [\bar{y} X_{11} + \xi Y_{11} \cos \delta] + \alpha q [\bar{c} \eta X_{32} + \xi Z_{32}]$



$\Theta = \tan^{-1} \frac{\xi \eta}{qR}$
 $I_1 = -\frac{\xi}{R+d} \cos \delta - I_4 \sin \delta$
 $I_2 = \ln(R+d) + I_3 \sin \delta$
 $I_3 = \frac{1}{\cos \delta} \frac{\bar{y}}{R+d} - \frac{1}{\cos^2 \delta} \left[\ln(R+\eta) - \sin \delta \ln(R+\bar{d}) \right]$
 $I_4 = \frac{\sin \delta}{\cos \delta} \frac{\xi}{R+d} + \frac{2}{\cos^2 \delta} \tan^{-1} \frac{\eta(X+q \cos \delta) + X(R+X) \sin \delta}{\xi(R+X) \cos \delta}$
 $X^2 = \xi^2 + q^2$
 $(I_3 = \frac{1}{2} \frac{\eta}{R+d} + \frac{\bar{y} q}{(R+d)^2} - \ln(R+\eta))$ if $\cos \delta = 0$
 $(I_4 = \frac{1}{2} \frac{\xi \bar{y}}{(R+d)^2})$ if $\cos \delta = 0$

TABLE 7
X-DERIVATIVES OF THE EQUATIONS IN TABLE 6.

X-derivative of Displacement due to a Finite Fault at (0, 0, -c; δ, L, W, U)

$$\begin{cases} \partial u_x / \partial x(x, y, z) = U/2\pi [j_1^A - \bar{j}_1^A + j_1^B + z j_1^C] & d = c - z & R^2 = \xi^2 + \eta^2 + q^2 \\ \partial u_y / \partial x(x, y, z) = U/2\pi [(j_2^A - \bar{j}_2^A + j_2^B + z j_2^C) \cos \delta - (j_3^A - \bar{j}_3^A + j_3^B + z j_3^C) \sin \delta] & p = y \cos \delta + d \sin \delta & \bar{y} = \eta \cos \delta + q \sin \delta \\ \partial u_z / \partial x(x, y, z) = U/2\pi [(j_2^A - \bar{j}_2^A + j_2^B - z j_2^C) \sin \delta + (j_3^A - \bar{j}_3^A + j_3^B - z j_3^C) \cos \delta] & q = y \sin \delta - d \cos \delta & \bar{d} = \eta \sin \delta - q \cos \delta \\ & \alpha = (\lambda + \mu)/(\lambda + 2\mu) & \bar{c} = \bar{d} + z \end{cases}$$

$$j_1^A = \partial f_1^A / \partial x(\xi, \eta, z) \Big|_{z=0}^{z=-L} \Big|_{\eta=0}^{\eta=W} \quad \bar{j}_1^A = \partial f_1^A / \partial x(\xi, \eta, -z) \quad j_1^B = \partial f_1^B / \partial x(\xi, \eta, z) \quad j_1^C = \partial f_1^C / \partial x(\xi, \eta, z)$$

Type	∂f ^A /∂x	∂f ^B /∂x	∂f ^C /∂x	
Strike 	$-\frac{1-\alpha}{2} q Y_{11} - \frac{\alpha}{2} \xi^2 q Y_{32}$ $-\frac{\alpha}{2} \frac{\xi q}{R^2}$ $\frac{1-\alpha}{2} \xi Y_{11} + \frac{\alpha}{2} \xi q^2 Y_{32}$	$\xi^2 q Y_{32}$ $\frac{\xi q}{R^2}$ $-\xi q^2 Y_{32}$	$-\frac{1-\alpha}{\alpha} J_1 \sin \delta$ $-\frac{1-\alpha}{\alpha} J_2 \sin \delta$ $-\frac{1-\alpha}{\alpha} J_3 \sin \delta$	$(1-\alpha) Y_0 \cos \delta$ $-(1-\alpha) \xi \left[\frac{\cos \delta}{R^2} + 2q Y_{32} \sin \delta \right] + \alpha \frac{3\bar{c} \xi q}{R^2}$ $-(1-\alpha) \xi q Y_{32} \cos \delta$ $+\alpha \xi \left[\frac{3\bar{c} \eta}{R^2} - z Y_{32} - Z_{32} - Z_0 \right]$
Dip 	$-\frac{\alpha}{2} \frac{\xi q}{R^2}$ $-\frac{q}{2} Y_{11} - \frac{\alpha}{2} \frac{\eta q}{R^2}$ $\frac{1-\alpha}{2} \frac{1}{R} + \frac{\alpha}{2} \frac{q^2}{R^2}$	$\frac{\xi q}{R^2}$ $\frac{\eta q}{R^2} + q Y_{11}$ $-\frac{q^2}{R^2}$	$+\frac{1-\alpha}{\alpha} J_4 \sin \delta \cos \delta$ $+\frac{1-\alpha}{\alpha} J_5 \sin \delta \cos \delta$ $+\frac{1-\alpha}{\alpha} J_6 \sin \delta \cos \delta$	$-(1-\alpha) \frac{\xi}{R^2} \cos \delta + \xi q Y_{32} \sin \delta + \alpha \frac{3\bar{c} \xi q}{R^2}$ $-(1-\alpha) \frac{\bar{y}}{R^2}$ $+\alpha \frac{3\bar{c} \eta q}{R^2}$ $\frac{\bar{d}}{R^2} - Y_0 \sin \delta + \alpha \frac{\bar{c}}{R^2} \left[1 - \frac{3q^2}{R^2} \right]$
Tensile 	$-\frac{1-\alpha}{2} \xi Y_{11} + \frac{\alpha}{2} \xi q^2 Y_{32}$ $-\frac{1-\alpha}{2} \frac{1}{R} + \frac{\alpha}{2} \frac{q^2}{R^2}$ $-\frac{1-\alpha}{2} q Y_{11} - \frac{\alpha}{2} q^3 Y_{32}$	$-\xi q^2 Y_{32}$ $-\frac{q^2}{R^2}$ $q^3 Y_{32}$	$-\frac{1-\alpha}{\alpha} J_4 \sin^2 \delta$ $-\frac{1-\alpha}{\alpha} J_5 \sin^2 \delta$ $-\frac{1-\alpha}{\alpha} J_6 \sin^2 \delta$	$(1-\alpha) \frac{\xi}{R^2} \sin \delta + \xi q Y_{32} \cos \delta + \alpha \xi \left[\frac{3\bar{c} \eta}{R^2} - 2Z_{32} - Z_0 \right]$ $(1-\alpha) 2 Y_0 \sin \delta$ $-\frac{\bar{d}}{R^2} + \alpha \frac{\bar{c}}{R^2} \left[1 - \frac{3q^2}{R^2} \right]$ $-(1-\alpha) \left[\frac{\bar{y}}{R^2} - Y_0 \cos \delta \right]$ $-\alpha \left[\frac{3\bar{c} \eta q}{R^2} - q Z_0 \right]$

$J_1 = J_5 \cos \delta - J_6 \sin \delta$
 $J_2 = \frac{\xi \bar{y}}{R+d} D_{11}$
 $J_3 = \frac{1}{\cos \delta} [K_1 - J_2 \sin \delta]$
 $J_4 = -\xi Y_{11} - J_2 \cos \delta + J_3 \sin \delta$
 $J_5 = \frac{1}{\cos \delta} [K_2 - J_5 \sin \delta]$
 $J_6 = \frac{1}{\cos \delta} [K_3 - J_5 \sin \delta]$
 $K_1 = \frac{\xi}{\cos \delta} [D_{11} - Y_{11} \sin \delta]$
 $K_2 = \frac{1}{R} + K_3 \sin \delta$
 $K_3 = \frac{1}{\cos \delta} [q Y_{11} - \bar{y} D_{11}]$
 $D_{11} = \frac{1}{R(R+d)}$
 $(J_3 = -\frac{\xi}{(R+d)^2} [q^2 D_{11} - \frac{1}{2}])$ if $\cos \delta = 0$
 $(J_5 = -[\frac{\bar{d}}{R+d} + \frac{\bar{y}^2}{R+d}]) D_{11}$
 $(K_3 = \frac{\sin \delta}{R+d} [q^2 D_{11} - 1])$ if $\cos \delta = 0$
 $(K_1 = \frac{\xi q}{R+d} D_{11})$ if $\cos \delta = 0$

DISCUSSION

In the preceding sections, a complete set of closed analytical expressions was derived in a unified manner for the internal displacements and strains due to shear and tensile faults in a half-space for both point and finite rectangular sources. We have basically followed Iwasaki and Sato's (1979) formulation, adding the new expressions for internal deformation fields due to a general point tensile source and a vertical finite tensile fault, as well as the internal strain field due to an arbitrary point source. Obtained formula were presented with table forms in Tables 2 through 9. Since they are particularly compact and systematic, they will not only save computational costs but also diminish probable coding errors.

All the formula are composed of infinite medium terms (part A), a surface deformation related term (part B), and a depth multiplied term (part C). As a subset of these formula, the deformation in an infinite medium can be expressed by a term that includes $\mathbf{u}_A^\circ(x, y, -z)$ for point sources and $f^A(\xi, \eta, -z)$ for finite faults. Also, the surface deformation can be expressed by the following subset:

$$\left\{ \begin{array}{l} \mathbf{u}(x, y, 0) = \mathbf{u}_B(x, y, 0) \\ \frac{\partial \mathbf{u}}{\partial x}(x, y, 0) = \frac{\partial \mathbf{u}_B}{\partial x}(x, y, 0) \\ \frac{\partial \mathbf{u}}{\partial y}(x, y, 0) = \frac{\partial \mathbf{u}_B}{\partial y}(x, y, 0) \\ \frac{\partial \mathbf{u}}{\partial z}(x, y, 0) = 2 \frac{\partial \mathbf{u}_A}{\partial z}(x, y, 0) + \frac{\partial \mathbf{u}_B}{\partial z}(x, y, 0) + \mathbf{u}_C(x, y, 0). \end{array} \right. \quad \begin{array}{l} (18) \\ (19) \\ (20) \\ (21) \end{array}$$

Next, let us discuss the mathematical singular points that are included in the expressions derived in the previous sections. We will investigate practical methods to avoid these mathematical singularities, as well as ways to avoid the computational instabilities that occasionally arise for some special conditions and cause trouble in the course of numerical calculation.

In the case of a point source, the problem is simple. The equations listed in Tables 2 through 5 become singular only when $R = 0$, because the factor $R + d$, which is included in the denominators of I° , J° , and K° is always positive unless $R = 0$. The case $R = 0$ occurs when an observation point coincides with the source position. Since this kind of singularity is so essential, we cannot remove the difficulty. The practical way to avoid the trouble is to set the output to a flag for a sufficiently small R .



In the case of a finite rectangular source, we also cannot escape from the essential singularities that arise when an observation point lies on the fault edges. We must set the output to a flag, as before. Apart from these intrinsic singularities, there exist other kinds of mathematical singularities, which can be classified in the following four categories. They arise at special points, as illustrated in Figure 5. For these singular points, we can avoid trouble by applying the following rules to the equations in Tables 6 through 9. These rules were found by returning to the integral (13) and carefully checking each special case.

TABLE 8
 Y-DERIVATIVES OF THE EQUATIONS IN TABLE 6. J_1 TO J_6 ARE LISTED IN TABLE 7.

Y-derivative of Displacement due to a Finite Fault at $(0, 0, -c; \delta, L, W, U)$

$$\begin{cases} \partial u_x / \partial y(x, y, z) = U/2\pi [k_1^A - \tilde{k}_1^A + k_1^B + z k_1^C] & R^2 = \xi^2 + \eta^2 + q^2 \\ \partial u_y / \partial y(x, y, z) = U/2\pi [(k_2^A - \tilde{k}_2^A + k_2^B + z k_2^C) \cos \delta - (k_3^A - \tilde{k}_3^A + k_3^B + z k_3^C) \sin \delta] & \tilde{y} = \eta \cos \delta + d \sin \delta \\ \partial u_z / \partial y(x, y, z) = U/2\pi [(k_2^A - \tilde{k}_2^A + k_2^B - z k_2^C) \sin \delta + (k_3^A - \tilde{k}_3^A + k_3^B - z k_3^C) \cos \delta] & \tilde{d} = \eta \sin \delta - q \cos \delta \\ & \tilde{c} = \tilde{d} + z \end{cases}$$

$$k_i^A = \partial f_i^A / \partial y(\xi, \eta, z) \Big|_{\xi=z, \eta=y}^{z=-L, y=p-W} \quad \tilde{k}_i^A = \partial f_i^A / \partial y(\xi, \eta, -z) \quad k_i^B = \partial f_i^B / \partial y(\xi, \eta, z) \quad k_i^C = \partial f_i^C / \partial y(\xi, \eta, z)$$

Type	$\partial f^A / \partial y$	$\partial f^B / \partial y$	$\partial f^C / \partial y$
Strike 	$\frac{1-\alpha}{2} \xi Y_{11} \sin \delta + \frac{\tilde{d}}{2} X_{11} + \frac{\alpha}{2} \xi F$	$-\xi F - \tilde{d} X_{11} + \frac{1-\alpha}{\alpha} [\xi Y_{11} + J_4] \sin \delta$	$-\alpha \xi Q$
Dip 	$\frac{1-\alpha}{2} [\cos \delta + q Y_{11} \sin \delta] - \frac{\alpha}{2} q F$	$-\frac{1-\alpha}{\alpha} [q Y_{11} - J_6] \sin \delta$	$2(1-\alpha) \left[\frac{\tilde{d}}{R^3} - Y_0 \sin \delta \right] \sin \delta - \frac{\tilde{y}}{R^3} \cos \delta - \alpha \left[\frac{\tilde{c} + \tilde{d}}{R^3} \sin \delta - \frac{\eta}{R^3} - \frac{3\tilde{c}\tilde{y}q}{R^5} \right]$
Tensile 	$\frac{1-\alpha}{2} \tilde{d} X_{11} + \frac{\xi}{2} Y_{11} \sin \delta + \frac{\alpha}{2} \eta G$	$-\frac{1-\alpha}{\alpha} J_1 \sin \delta \cos \delta$	$-(1-\alpha) \frac{\eta}{R^3} + Y_0 \sin^2 \delta - \alpha \left[\frac{\tilde{c} + \tilde{d}}{R^3} \sin \delta - \frac{3\tilde{c}\tilde{y}q}{R^5} \right]$
	$\frac{1-\alpha}{2} \tilde{y} X_{11} - \frac{\alpha}{2} q G$	$-\frac{1-\alpha}{\alpha} J_2 \sin \delta \cos \delta$	$(1-\alpha) [X_{11} - \tilde{y}^2 X_{32}] - \alpha \tilde{c} [(\tilde{d} + 2q \cos \delta) X_{32} - \tilde{y}\eta q X_{53}]$
	$\frac{1-\alpha}{2} [\frac{\cos \delta}{R} + q Y_{11} \sin \delta] - \frac{\alpha}{2} q F$	$-\frac{1-\alpha}{\alpha} J_1 \sin^2 \delta$	$\xi P \sin \delta + \tilde{y}\tilde{d} X_{32} + \alpha \tilde{c} [(\tilde{y} + 2q \sin \delta) X_{32} - \tilde{y}q^2 X_{53}]$
	$\frac{1-\alpha}{2} [\tilde{d} X_{11} + \xi Y_{11} \sin \delta] + \frac{\alpha}{2} q H$	$-\frac{1-\alpha}{\alpha} J_3 \sin^2 \delta$	$(1-\alpha) \left[\frac{q}{R^3} + Y_0 \sin \delta \cos \delta \right] + \alpha \left[\frac{z}{R^3} \cos \delta + \frac{3\tilde{c}\tilde{d}q}{R^5} - q Z_0 \sin \delta \right]$

$$\begin{aligned} E &= \frac{\sin \delta}{R} - \frac{\tilde{y}q}{R^3} & P &= \frac{\cos \delta}{R^3} + q Y_{32} \sin \delta \\ F &= \frac{\tilde{d}}{R^3} + \xi^2 Y_{32} \sin \delta & H &= \tilde{d}q X_{32} + \xi q Y_{52} \sin \delta \\ & & Q &= \frac{3\tilde{c}\tilde{d}}{R^5} - (z Y_{32} + Z_{32} + Z_0) \sin \delta \end{aligned}$$

TABLE 9
 DERIVATIVES OF THE EQUATIONS IN TABLE 6. K_1 TO K_4 AND D_{11} ARE LISTED IN TABLE 7.

Z-derivative of Displacement due to a Finite Fault at $(0, 0, -c; \delta, L, W, U)$

$$\begin{cases} \partial u_x / \partial x(x, y, z) = U/2\pi [v_1^A + \tilde{v}_1^A + w_1^B + u_1^C + z v_1^D] \\ \partial u_y / \partial x(x, y, z) = U/2\pi [(v_2^A + \tilde{v}_2^A + w_2^B + v_2^C + z v_2^D) \cos \delta - (v_3^A + \tilde{v}_3^A + w_3^B + v_3^C + z v_3^D) \sin \delta] \\ \partial u_z / \partial x(x, y, z) = U/2\pi [(v_4^A + \tilde{v}_4^A + w_4^B - v_4^C - z v_4^D) \sin \delta + (v_5^A + \tilde{v}_5^A + w_5^B - v_5^C - z v_5^D) \cos \delta] \end{cases}$$

$$v_i^A = \partial f_i^A / \partial x(\xi, \eta, z) \Big|_{\xi=x, \eta=z}^{z=-L, \eta=p-w} \quad \tilde{v}_i^A = \partial f_i^A / \partial x(\xi, \eta, -z) \Big|_{\xi=p, \eta=z} \quad w_i^B = \partial f_i^B / \partial z(\xi, \eta, z) \Big|_{\xi=\xi, \eta=z} \quad u_i^C = \partial f_i^C / \partial z(\xi, \eta, z) \Big|_{\xi=\xi, \eta=z}$$

Type	$\partial f^A / \partial z$	$\partial f^B / \partial z$	$\partial f^C / \partial z$
Strike	$\frac{1-\alpha}{2} \xi Y_{11} \cos \delta + \frac{\tilde{y}}{2} X_{11} + \frac{\alpha}{2} \xi F'$	$-\xi F' - \tilde{y} X_{11} + \frac{1-\alpha}{\alpha} K_1 \sin \delta$	$(1-\alpha) \xi P' \cos \delta$
Dip	$\frac{\alpha}{2} E'$	$-\frac{1-\alpha}{\alpha} K_3 \sin \delta \cos \delta$	$-\frac{q}{R^3} + Y_0 \sin \delta \cos \delta - \alpha \left[\frac{\tilde{c} + \tilde{d}}{R^3} \cos \delta + \frac{3\tilde{c}\tilde{d}q}{R^5} \right]$
	$-\frac{1-\alpha}{2} \left[\frac{\sin \delta}{R} - q Y_{11} \cos \delta \right] - \frac{\alpha}{2} q F'$	$-\frac{1-\alpha}{\alpha} \tilde{y} D_{11} \sin \delta$	$2(1-\alpha) \left[\frac{\tilde{y}}{R^3} - Y_0 \cos \delta \right] \sin \delta + \frac{\tilde{d}}{R^3} \cos \delta - \alpha \left[\frac{\tilde{c} + \tilde{d}}{R^3} \cos \delta + \frac{3\tilde{c}\tilde{d}q}{R^5} \right]$
Tensile	$\frac{\alpha}{2} E'$	$-\frac{1-\alpha}{\alpha} K_4 \sin \delta \cos \delta$	$-\xi P' \sin \delta + X_{11} - \tilde{d}^2 X_{32} - \alpha \tilde{c} \left[\frac{\tilde{c} + \tilde{d}}{R^3} \sin \delta - \frac{3\tilde{c}\tilde{y}q}{R^5} - Y_0 \sin^2 \delta + q Z_0 \cos \delta \right]$
	$-\frac{1-\alpha}{2} \tilde{d} X_{11}$	$-\frac{1-\alpha}{\alpha} K_2 \sin \delta$	$-\frac{q}{R^3} + Y_0 \sin \delta \cos \delta - \alpha \left[\frac{\tilde{c} + \tilde{d}}{R^3} \cos \delta + \frac{3\tilde{c}\tilde{d}q}{R^5} \right]$
U	$\frac{1-\alpha}{2} \left[\frac{\sin \delta}{R} - q Y_{11} \cos \delta \right] - \frac{\alpha}{2} q F'$	$-\frac{1-\alpha}{\alpha} \xi Y_{11} \cos \delta + \frac{\tilde{y}}{2} X_{11} + \frac{\alpha}{2} \xi F'$	$(1-\alpha) \xi P' \cos \delta$
	$-\frac{1-\alpha}{2} \tilde{d} X_{11}$	$-\frac{1-\alpha}{\alpha} \tilde{y} D_{11} \sin \delta$	$2(1-\alpha) \left[\frac{\tilde{y}}{R^3} - Y_0 \cos \delta \right] \sin \delta + \frac{\tilde{d}}{R^3} \cos \delta - \alpha \left[\frac{\tilde{c} + \tilde{d}}{R^3} \cos \delta + \frac{3\tilde{c}\tilde{d}q}{R^5} \right]$
U	$\frac{\alpha}{2} q G'$	$-\frac{1-\alpha}{\alpha} K_3 \sin^2 \delta$	$-\xi P' \sin \delta + X_{11} - \tilde{d}^2 X_{32} - \alpha \tilde{c} \left[\frac{\tilde{c} + \tilde{d}}{R^3} \sin \delta - \frac{3\tilde{c}\tilde{y}q}{R^5} - Y_0 \sin^2 \delta + q Z_0 \cos \delta \right]$
	$-\frac{1-\alpha}{2} q G'$	$-\frac{1-\alpha}{\alpha} \xi D_{11} \sin^2 \delta$	$-\frac{q}{R^3} + Y_0 \sin \delta \cos \delta - \alpha \left[\frac{\tilde{c} + \tilde{d}}{R^3} \cos \delta + \frac{3\tilde{c}\tilde{d}q}{R^5} \right]$
U	$\frac{\alpha}{2} q H'$	$-\frac{1-\alpha}{\alpha} K_4 \sin^2 \delta$	$(1-\alpha) 2 \xi P' \sin \delta$
	$-\frac{1-\alpha}{2} q H'$	$-\frac{1-\alpha}{\alpha} \xi D_{11} \sin^2 \delta$	$-\xi P' \sin \delta + X_{11} - \tilde{d}^2 X_{32} - \alpha \tilde{c} \left[\frac{\tilde{c} + \tilde{d}}{R^3} \sin \delta - \frac{3\tilde{c}\tilde{y}q}{R^5} - Y_0 \sin^2 \delta + q Z_0 \cos \delta \right]$
	$E' = \frac{\cos \delta}{R} + \frac{\tilde{d}q}{R^3}$	$G' = 2X_{11} \cos \delta + \tilde{d}q X_{32}$	$P' = \frac{\sin \delta}{R^3} - q Y_{32} \cos \delta$
	$F' = \frac{\tilde{y}}{R^3} + \xi^2 Y_{32} \cos \delta$	$H' = \tilde{y}q X_{32} + \xi q Y_{32} \cos \delta$	$Q' = \frac{3\tilde{c}\tilde{y}}{R^5} + q Y_{32} - (z Y_{32} + Z_{32} + Z_0) \cos \delta$

$$\begin{aligned} d &= c - z & R^2 &= \xi^2 + \eta^2 + q^2 \\ p &= y \cos \delta + d \sin \delta & \tilde{y} &= \eta \cos \delta + q \sin \delta \\ q &= y \sin \delta - d \cos \delta & \tilde{d} &= \eta \sin \delta - q \cos \delta \\ \alpha &= (\lambda + \mu) / (\lambda + 2\mu) & \tilde{c} &= \tilde{d} + z \end{aligned}$$

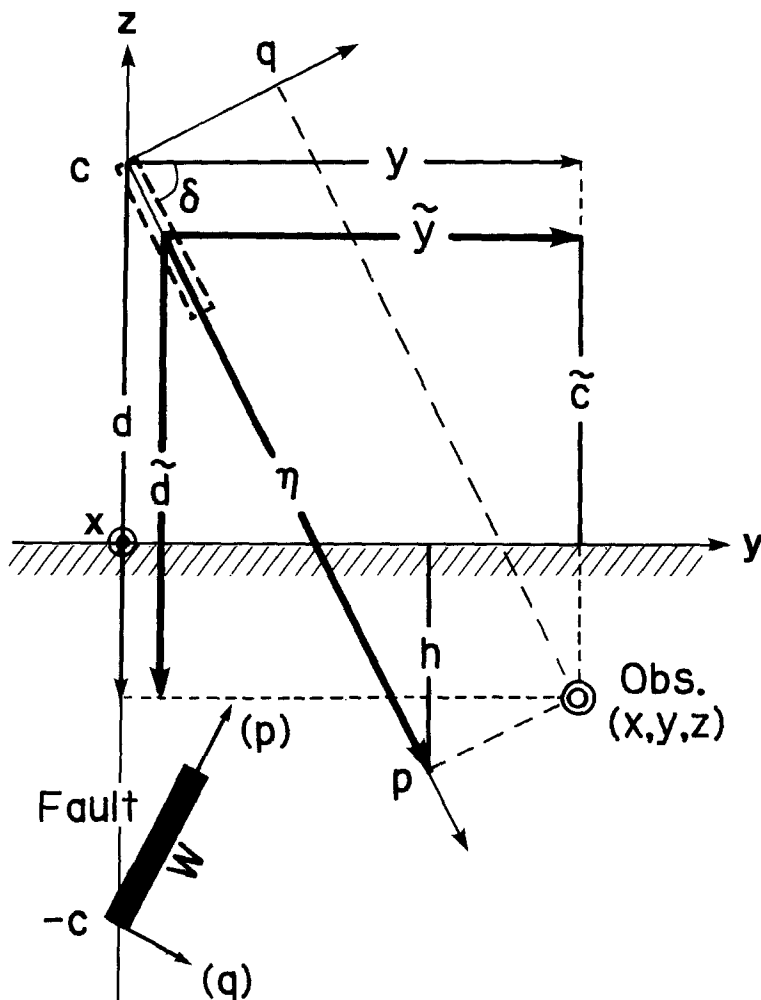

FIG. 4. Physical meaning of some constants and variables that are related to an image fault surface and appear in Tables 6 through 9. The axes, (p) and (q) , which are related to the real fault, correspond to the p and q axes for the image fault. The positive x axis is out of the page.

(i) When $q = 0$ (this occurs on the planes that include the fault surface and its image), set Θ in Table 6 to be zero.

(ii) When $\xi = 0$ (this occurs on the vertical planes that include the edges that are perpendicular to the fault strike), set I_4 in Table 6 to be zero.

(iii) When $R + \xi = 0$ (this occurs along the lines extending the edges that are parallel to the fault strike and $x < 0$), set all the terms that contain $R + \xi$ in their denominators to be zero and replace $\ln(R + \xi)$ to $-\ln(R - \xi)$.

(iv) When $R + \eta = 0$ (this occurs along the lines extending the edges that are perpendicular to the fault strike and $p < 0$), set all the terms that contain $R + \eta$ in their denominators to be zero and replace $\ln(R + \eta)$ to $-\ln(R - \eta)$.

On the fault surface excluding its edges, the above rule (i) sets the displacement parallel to dislocation vector to the average of the displacements at both sides of the fault, while all the other components are kept to be continuous across the fault surface.

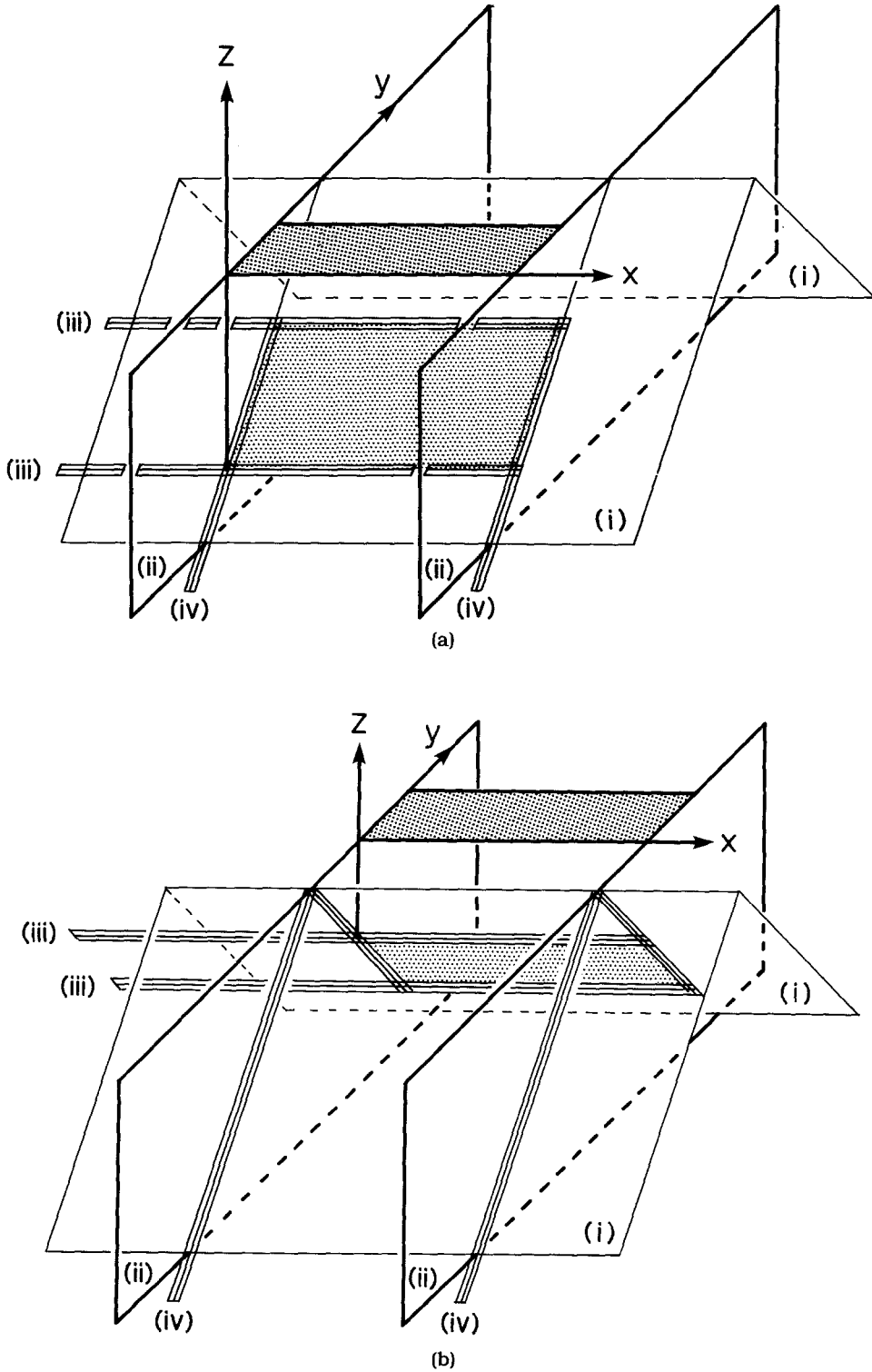

FIG. 5. The places where mathematical singularities appear in the expressions for the deformation field due to a finite rectangular source. Shaded parts show the fault plane and its projection onto the free surface. Marks (i) to (iv) correspond to the conditions described in the text. (a) is for the case, $\sin \delta > 0$, while (b) is for $\sin \delta < 0$.

In the practical situations, there are two problems with applying the above four rules. First, even if one of the above conditions is met mathematically, the numerical condition may not be satisfied because of computational errors. Second, if the condition is not exactly satisfied but is nearly satisfied, the numerical results may give unreasonably big values. To overcome these diffi-

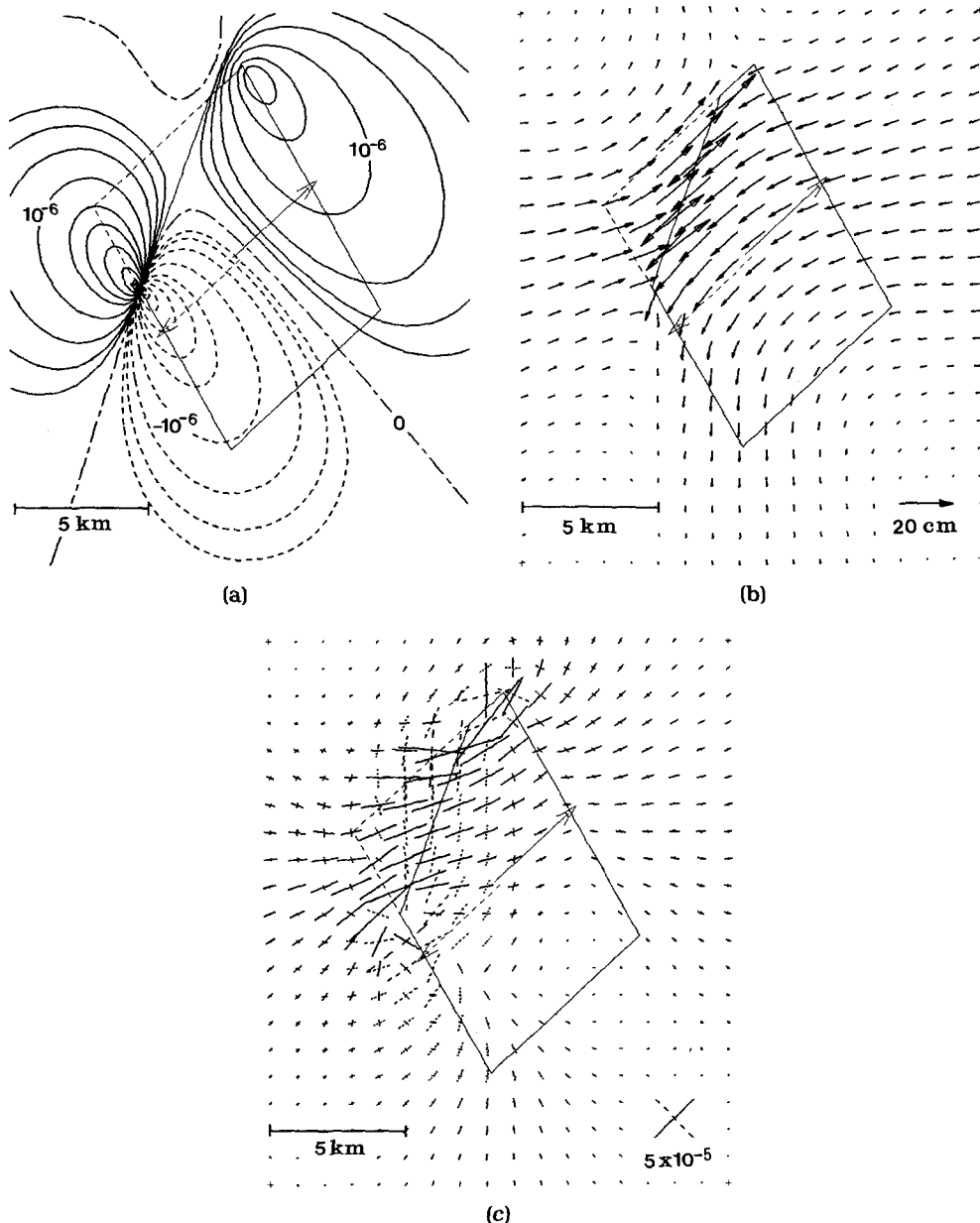

FIG. 6. An example of the internal deformation field due to an inclined dip-slip fault. Figure 8 shows the configuration of the fault model and the observation plane which crosses the fault surface. (a) Contour map of the volume dilation. A parallelogram shows the projected fault surface. The solid line shows part of the fault plane that lies above the observation plane, while the dashed line shows one below the observation plane. (b) Vector map of the in-plane displacements. (c) Distribution of the 3-D principal strain projected onto the observation plane.

culties, one can apply the above rules when the quantities, ξ , η , or q becomes sufficiently small rather than when they are exactly zero. By the same reason, the alternate expressions for I , J , and K needed for the calculation of vertical faults ($\delta \approx \pi/2$) in Tables 6 through 9 should be used when $\cos \delta$ is sufficiently small rather than when it is exactly zero.

NUMERICAL RESULTS

Based on the presentations in Tables 2 through 9 and taking into account the practical considerations discussed in the preceding section, we have established a computer program to calculate internal deformation fields due to a multiple source that can be arbitrarily composed of shear and tensile faults of both point and finite rectangular types. The program can draw contour, vector, or tensor maps of in-plane or normal components of displacement and strain on an observation plane arbitrarily oriented in the half-space. Figure 6 shows an example of the output from this program system. Here, a contour map of volume dilatation, a vector map of in-plane displacements, and a distribution of projected 3-D principal strain are displayed on a plane crossing the fault surface (Fig. 8 shows the fault configuration).

As another example of the numerical calculation, Figure 7 illustrates the schematic 3-D deformation of an elastic half-space due to slip on a buried vertical strike-slip, dip-slip, or tensile fault. The figure shows a $50 \times 50 \times 50$ km cube within an elastic body assuming that the top of the cube represents the free surface. A vertical fault is assumed to be located at the center of the block with a length of 20 km and a height of 10 km, occupying a depth range from 10 to 20 km. Three perpendicular arrows denote the displacement amplitude in units of $0.1U$, where U stands for the dislocation amount.

Next, let us see an example of the depth dependency of the strain and tilt fields due to a buried finite rectangular source. As is illustrated in Figure 8, the size of the fault is assumed to be 12×8 km, and the slip is 50 cm. These parameters approximately represent a magnitude 6 earthquake source. Assuming $\lambda = \mu$, $c = 10$ km, and $\delta = 40^\circ$, the strain and tilt beneath an observation point $(x, y) = (25, 15)$ km were evaluated. For the case of the tilt observations, we should be careful because of the difference between the physical quantity observed by water-tube tiltmeters and that by pendulum-type borehole tiltmeters. The former measures $\partial u_z / \partial x$, whereas the latter measures $\partial u_x / \partial z$. On the ground surface, both quantities coincide in amplitude with each other, because $\sigma_{xz} = \mu(\partial u_z / \partial x + \partial u_x / \partial z)$ must vanish at the free surface of a half-space.

Figure 9 shows the depth variation of the above quantities, $\partial u_z / \partial x$ and $-\partial u_x / \partial z$, as well as that of an areal dilatation $\Delta = \partial u_x / \partial x + \partial u_y / \partial y$. According to this figure, the strain or tilt rapidly changes even at very shallow depths. So, when we use strain or tilt data observed in sufficiently deep boreholes, we must be cautious to compare the observation with theory.

To any interested researchers, the author is ready to provide the source code for subroutine programs that correspond to Tables 2 through 9.

ACKNOWLEDGMENTS

A part of this study was advanced during the author's stay in U. S. Geological Survey in Menlo Park. He is grateful to Drs. M. Johnston and P. Segall for critical reading of the manuscript and for many useful suggestions to help make this paper clear. Also, the discussions with Drs. R. Wesson and W. Thatcher were stimulating to accomplish this work.

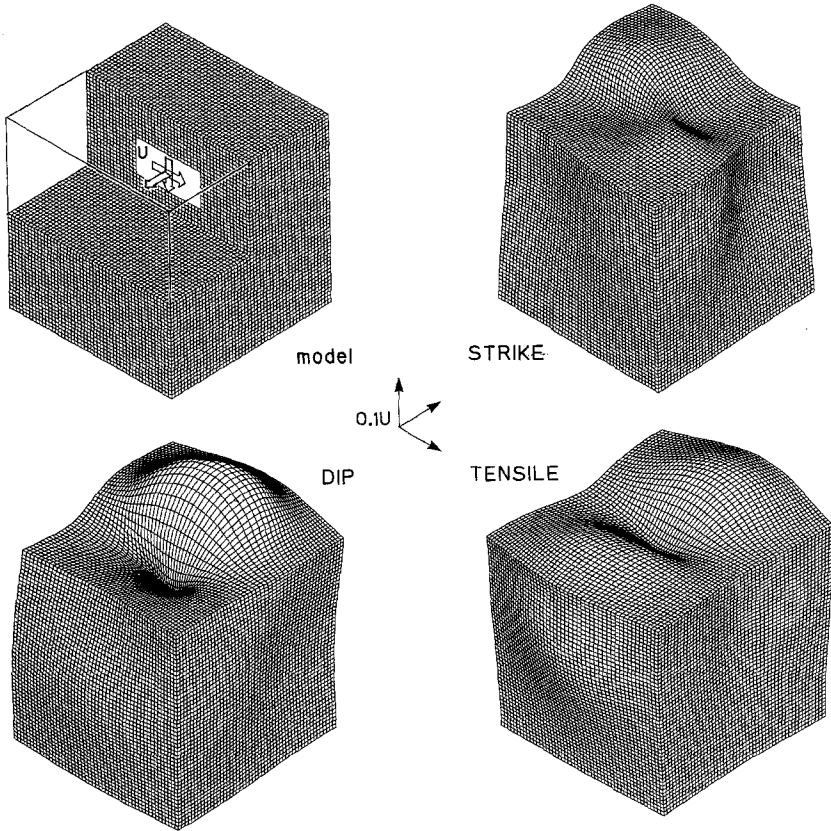

FIG. 7. Schematic 3-D deformation of an elastic half-space due to slip on a vertical strike-slip, dip-slip, or tensile fault. The block has a size of 50 km, the top of which corresponds to the free surface. The vertical fault is 20 km long and 10 km wide extending from 10 to 20 km depth. U stands for the dislocation amount.

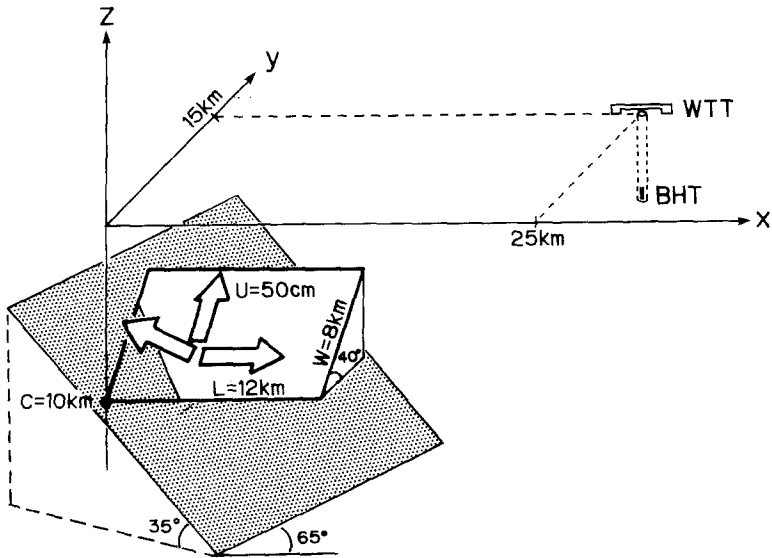

FIG. 8. An example of the tilt observations at ground surface and in a borehole. Note that a water-tube tiltmeter (WTT) measures $\partial u_z / \partial x$, while a borehole tiltmeter (BHT) measures $\partial u_x / \partial z$. A shaded oblique plane crossing the fault surface corresponds to the observation plane in Figure 6.

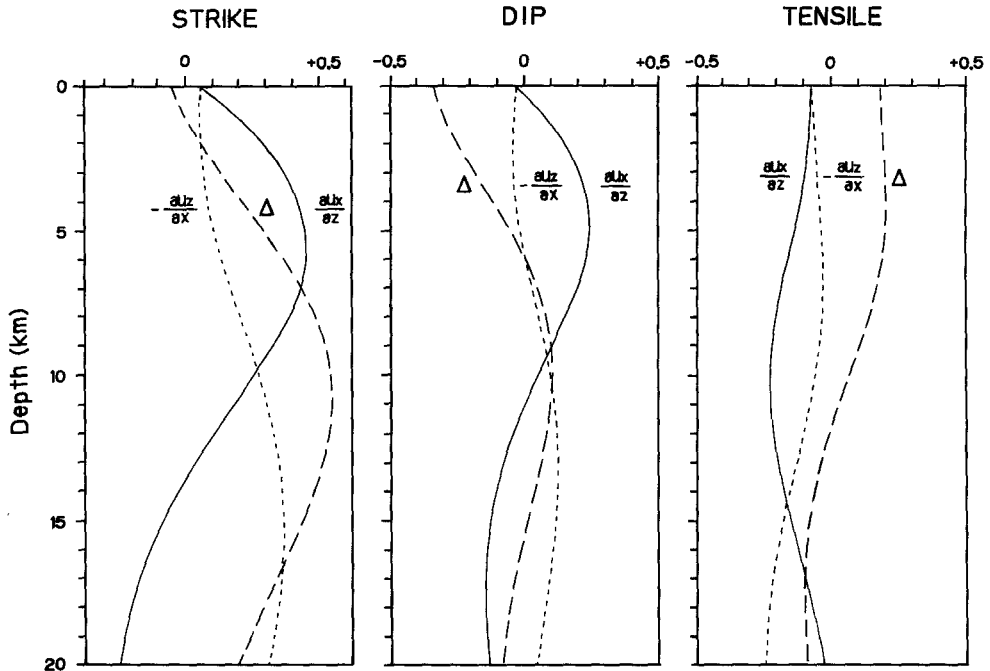

FIG. 9. The depth dependency of $\partial u_x/\partial z$, $-\partial u_x/\partial x$ and areal dilatation $\Delta = \partial u_x/\partial x + \partial u_y/\partial y$ beneath the observation point illustrated in Figure 8. A unit of strain is 10^{-6} .

REFERENCES

- Alewine, R. W. (1974). Application of linear inversion theory toward the estimation of seismic source parameters, *Ph.D. Thesis*, California Institute of Technology, Pasadena, California, 303 pp.
- Chinnery, M. A. (1961). The deformation of ground around surface faults, *Bull. Seism. Soc. Am.* **51**, 355-372.
- Chinnery, M. A. (1963). The stress changes that accompany strike-slip faulting, *Bull. Seism. Soc. Am.* **53**, 921-932.
- Converse, G. (1973). Equations for the displacements and displacement derivatives due to a rectangular dislocation in a three-dimensional elastic half-space, *User's Manual For DIS3D*, U. S. Geological Survey, Menlo Park, 119-148.
- Erickson, L. L. (1986). A three-dimensional dislocation program with applications to faulting in the earth, *M.Sc. Thesis*, Stanford University, Stanford, California, 167 pp.
- Iwasaki, T. and R. Sato (1979). Strain field in a semi-infinite medium due to an inclined rectangular fault, *J. Phys. Earth* **27**, 285-314.
- Kawasaki, I., Y. Suzuki, and R. Sato (1973). Seismic waves due to a shear fault in a semi-infinite medium. Part I. Point source, *J. Phys. Earth* **21**, 251-284.
- Kawasaki, I., Y. Suzuki, and R. Sato (1975). Seismic waves due to a shear fault in a semi-infinite medium. Part II. Moving source, *J. Phys. Earth* **23**, 43-61.
- Love, A. E. H. (1927). *A Treatise on the Mathematical Theory of Elasticity*, 4th ed., Dover, New York, 643 pp.
- Mansinha, L. and D. E. Smylie (1967). Effect of earthquakes on the Chandler wobble and the secular polar shift, *J. Geophys. Res.* **72**, 4731-4743.
- Mansinha, L. and D. E. Smylie (1971). The displacement fields of inclined faults, *Bull. Seism. Soc. Am.* **61**, 1433-1440.
- Maruyama, T. (1964). Statical elastic dislocations in an infinite and semi-infinite medium, *Bull. Earthq. Res. Inst., Tokyo Univ.* **42**, 289-368.
- Mindlin, R. D. (1936). Force at a point in the interior of a semi-infinite solid, *Physics* **7**, 195-202.

- Okada, Y. (1980). Theoretical strain seismogram and its applications, *Bull. Earthq. Res. Inst., Tokyo Univ.* **55**, 101-168 (in Japanese with English abstract).
- Okada, Y. (1985). Surface deformation due to shear and tensile faults in a half-space, *Bull. Seism. Soc. Am.* **75**, 1135-1154.
- Okada, Y. and E. Yamamoto (1991). Dyke intrusion model for the 1989 seismovolcanic activity off Ito, central Japan, *J. Geophys. Res.* **96**, 10361-10376.
- Okubo, S. (1989). Gravity change caused by fault motion on a finite rectangular plane, *J. Geod. Soc. Japan* **35**, 159-164.
- Pan, E. (1989). Static response of a transversely isotropic and layered half-space to general dislocation sources, *Phys. Earth Planet. Interiors* **58**, 103-117.
- Press, F. (1965). Displacements, strains and tilts at tele-seismic distances, *J. Geophys. Res.* **70**, 2395-2412.
- Sasai, Y. (1980). Application of the elasticity theory of dislocations to tectonomagnetic modelling, *Bull. Earthq. Res. Inst., Tokyo Univ.* **55**, 387-447.
- Sato, R. and M. Matsu'ura (1974). Strains and tilts on the surface of a semi-infinite medium, *J. Phys. Earth* **22**, 213-221.
- Steketee, J. A. (1958). On Volterra's dislocation in a semi-infinite elastic medium, *Can. J. Phys.* **36**, 192-205.
- Tada, T. and M. Hashimoto (1987). Izu-Oshima eruption in 1986 and related crustal deformations, *Earth Monthly* **9**, 396-403 (in Japanese).
- Yamamoto, E., T. Kumagai, S. Shimada, and E. Fukuyama (1988). Crustal tilt movements associated with the 1986-1987 volcanic activities of Izu-Oshima Volcano: results of continuous crustal tilt observation at Gojinka and Habu, *Bull. Volcanol. Soc. Japan* **33**, S170-S178 (in Japanese with English abstract).
- Yamazaki, K. (1978). Theory of crustal deformation due to dilatancy and quantitative evaluation of earthquake precursors, *Sci. Rep. Tohoku Univ., Ser.5, Geophys.* **25**, 115-167.
- Yang, X. and P. Davis (1986). Deformation due to a rectangular tension crack in an elastic half-space, *Bull. Seism. Soc. Am.* **76**, 865-881.

NATIONAL RESEARCH INSTITUTE
FOR EARTH SCIENCE AND DISASTER PREVENTION
TSUKUBA, IBARAKI, 305 JAPAN

Manuscript received 9 October 1991